



US008233460B2

(12) **United States Patent**  
**Wong et al.**

(10) **Patent No.:** **US 8,233,460 B2**  
(45) **Date of Patent:** **\*Jul. 31, 2012**

(54) **COMMUNICATION SYSTEM WITH MAP OF INFORMATION PROVIDED FROM CONTROLLER TO ENABLE COMMUNICATION WITH NODES**

(51) **Int. Cl.** *H04J 3/00* (2006.01)  
(52) **U.S. Cl.** ..... 370/336; 455/436; 455/437; 455/439  
(58) **Field of Classification Search** ..... 455/436, 455/437, 439  
See application file for complete search history.

(75) Inventors: **Gabriel K. Wong**, Honolulu, HI (US);  
**Po S. Tsui**, Honolulu, HI (US)

(56) **References Cited**

(73) Assignee: **GPNE Corp.**, Honolulu, HI (US)

U.S. PATENT DOCUMENTS

(\* ) Notice: Subject to any disclaimer, the term of this patent is extended or adjusted under 35 U.S.C. 154(b) by 1212 days.

3,755,782 A 8/1973 Haas  
3,851,104 A 11/1974 Willard  
4,224,150 A 9/1980 Buriks  
(Continued)

This patent is subject to a terminal disclaimer.

FOREIGN PATENT DOCUMENTS

(21) Appl. No.: **11/781,859**

EP 0 282 028 A2 9/1988  
(Continued)

(22) Filed: **Jul. 23, 2007**

OTHER PUBLICATIONS

(65) **Prior Publication Data**

US 2008/0014953 A1 Jan. 17, 2008

Defendant Samsung Telecommunications America, LLC's Invalidation Contentions filed Oct. 8, 2007 in the United States District Court for the Eastern District of Texas Court Case No. 6:07-cv-59.

(Continued)

**Related U.S. Application Data**

(60) Continuation of application No. 11/668,922, filed on Jan. 30, 2007, now abandoned, which is a continuation of application No. 11/350,616, filed on Feb. 8, 2006, now Pat. No. 7,200,406, which is a continuation of application No. 09/847,005, filed on May 2, 2001, now Pat. No. 7,031,716, which is a continuation of application No. 09/594,662, filed on Jun. 15, 2000, now Pat. No. 6,282,406, which is a continuation of application No. 09/259,417, filed on Dec. 9, 1997, now Pat. No. 6,108,520, which is a continuation of application No. 08/608,629, filed on Feb. 29, 1996, now Pat. No. 5,729,827, which is a division of application No. 08/264,973, filed on Jun. 24, 1994, now Pat. No. 5,542,115.

*Primary Examiner* — Yuwen Pan  
(74) *Attorney, Agent, or Firm* — Fliesler Meyer LLP

(57) **ABSTRACT**

A communication system is provided that includes a controller providing a map of information to enable communication with a plurality of nodes. The information includes identification of two separate time slots, one for random access requests when a node initially contacts a controller and another for exclusively assigned access to transmit messages. The map further provides information to enable identification of the nodes and assigns transmission frequencies.

**136 Claims, 13 Drawing Sheets**

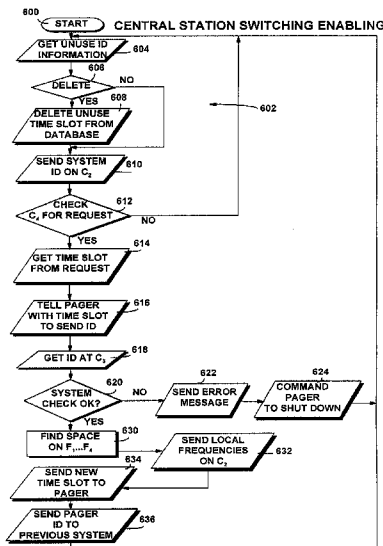

U.S. PATENT DOCUMENTS					
4,251,865 A	2/1981	Moore	5,276,682 A	1/1994	Van As
4,340,961 A	7/1982	Capel	5,276,703 A	1/1994	Budin
4,345,491 A	8/1982	Hannon	5,278,833 A	1/1994	Crisler
4,392,242 A	7/1983	Kai	5,285,496 A	2/1994	Frank
4,466,001 A	8/1984	Moore	5,297,143 A	3/1994	Fridrich
4,477,809 A	10/1984	Bose	5,297,144 A	3/1994	Gilbert
4,527,284 A	7/1985	Röttger	5,299,198 A	3/1994	Kay
4,553,263 A	11/1985	Smith	5,301,356 A	4/1994	Bodin
4,555,594 A	11/1985	Friedes	5,303,393 A	4/1994	Noreen
4,603,418 A	7/1986	Townsend	5,315,586 A	5/1994	Charvillat
4,608,711 A	8/1986	Goldman	5,335,356 A	8/1994	Andersson
4,644,347 A	2/1987	Lucas	5,341,397 A	8/1994	Gudmundson
4,644,351 A	2/1987	Zabarsky	5,353,285 A	10/1994	Van Der Plas
RE32,365 E	3/1987	Sebestyn	5,353,332 A	10/1994	Raith
4,713,808 A	12/1987	Gaskill	5,361,399 A	11/1994	Linguist
4,718,109 A	1/1988	Breeden	5,363,374 A	11/1994	Zein Al Abedeen
4,736,371 A	4/1988	Tejima	5,363,427 A	11/1994	Ekstrom
4,742,512 A	5/1988	Akashi	5,367,524 A	11/1994	Rideout, Jr.
4,747,122 A	5/1988	Bhagat	5,373,503 A	12/1994	Chen
4,815,073 A	3/1989	Grael	5,377,192 A	12/1994	Goodings
4,823,123 A	4/1989	Siwiak	5,384,777 A	1/1995	Ahmadi
4,825,193 A	4/1989	Siwiak	5,396,496 A	3/1995	Ito
4,845,491 A	7/1989	Fascenda	5,396,537 A	3/1995	Schwendeman
4,866,710 A	9/1989	Schaeffer	5,400,331 A	3/1995	Lucak
4,870,402 A	9/1989	DeLuca	5,404,355 A	4/1995	Raith
4,875,038 A	10/1989	Siwiak	5,404,392 A	4/1995	Miller
4,875,231 A	10/1989	Hara	5,420,851 A	5/1995	Seshadri
4,878,051 A	10/1989	Andros	5,420,864 A	5/1995	Dahlin
4,882,579 A	11/1989	Siwiak	5,420,909 A	5/1995	Ng
4,887,265 A	12/1989	Felix	5,422,656 A	6/1995	Allard
4,891,637 A	1/1990	Siwiak	5,440,555 A	8/1995	Momona
4,905,301 A	2/1990	Krolopp	5,446,769 A *	8/1995	Shaver et al. .... 375/134
4,914,649 A	4/1990	Schwendeman	5,451,839 A	9/1995	Rappaport
4,940,963 A	7/1990	Gutman	5,461,627 A	10/1995	Rypinski
4,940,974 A	7/1990	Sojka	5,463,675 A	10/1995	Gerszberg
RE33,417 E	10/1990	Bhagat	5,465,401 A	11/1995	Thompson
4,978,944 A	12/1990	Andros	5,471,474 A	11/1995	Grobicki
5,012,469 A	4/1991	Sardana	5,471,670 A	11/1995	Hess
5,025,442 A	6/1991	Lynk	5,481,537 A	1/1996	Crisler
5,029,164 A	7/1991	Goldstein	5,485,463 A	1/1996	Godoroja
5,043,721 A	8/1991	May	5,485,464 A	1/1996	Strodtbeck
5,068,916 A	11/1991	Harrison	5,487,174 A	1/1996	Persson
5,086,501 A	2/1992	DeLuca	5,491,469 A	2/1996	Schwendeman
5,088,094 A	2/1992	Grael	5,499,243 A	3/1996	Hall
5,103,445 A	4/1992	Ostlund	5,502,721 A	3/1996	Pohjakallio
5,109,400 A	4/1992	Patsiokas	5,504,803 A	4/1996	Yamada
5,109,544 A	4/1992	Mittel	5,521,925 A	5/1996	Merakos
5,111,197 A	5/1992	Ichikawa	5,524,278 A	6/1996	Williams
5,111,534 A	5/1992	Benner	5,539,730 A	7/1996	Dent
5,117,449 A	5/1992	Metroka	5,542,115 A	7/1996	Wong
5,119,375 A	6/1992	Paneth	5,544,222 A	8/1996	Robinson
5,119,502 A	6/1992	Kallin	5,548,631 A	8/1996	Krebs
5,121,115 A	6/1992	Andros	5,555,266 A	9/1996	Buchholz
5,121,387 A	6/1992	Gerhardt	5,559,804 A	9/1996	Amada
5,124,697 A	6/1992	Moore	5,594,949 A	1/1997	Andersson
5,127,100 A	6/1992	D'Amico	5,603,081 A	2/1997	Raith
5,128,934 A	7/1992	Jasinski	5,613,198 A	3/1997	Ahmadi
5,134,615 A	7/1992	Freeburg	5,613,207 A	3/1997	Wilson
5,142,279 A	8/1992	Jasinski	5,613,212 A	3/1997	Wong
5,142,533 A	8/1992	Crisler	5,625,878 A	4/1997	Löppönen
5,153,580 A	10/1992	Pollack	5,625,880 A	4/1997	Goldburg
5,166,929 A	11/1992	Lo	5,627,881 A	5/1997	Fletcher
5,170,487 A	12/1992	Peek	5,634,193 A	5/1997	Ghisler
5,195,090 A	3/1993	Bolliger	5,642,405 A	6/1997	Fischer
5,197,125 A	3/1993	Engel	5,680,398 A	10/1997	Robinson
5,206,855 A	4/1993	Schwendeman	5,689,807 A	11/1997	Wong
5,210,771 A	5/1993	Schaeffer	5,717,688 A	2/1998	Belanger
5,224,150 A	6/1993	Neustein	5,729,827 A	3/1998	Wong
5,235,327 A	8/1993	Igarashi	5,778,316 A	7/1998	Persson
5,239,306 A	8/1993	Siwiak	5,870,426 A	2/1999	Yokey
5,239,677 A	8/1993	Jasinski	5,901,357 A	5/1999	D'Avello et al.
5,247,700 A	9/1993	Wohl	5,915,219 A	6/1999	Pöyhönen
5,247,702 A	9/1993	Su	5,956,643 A	9/1999	Benveniste
5,254,986 A	10/1993	DeLuca	6,108,520 A	8/2000	Wong
5,255,265 A	10/1993	Eng	6,122,527 A	9/2000	Robinson
5,260,986 A	11/1993	Pershan	6,212,176 B1	4/2001	Andersson
5,261,118 A	11/1993	Vanderspool, II	6,243,071 B1	6/2001	Shwartz
5,267,244 A	11/1993	Messerschmitt	6,252,868 B1	6/2001	Diachina
			6,282,406 B1	8/2001	Wong

6,393,002	B1	5/2002	Paneth
6,430,417	B1	8/2002	Raith
6,434,406	B2	8/2002	Lee
6,481,634	B1	11/2002	Zosimadis
7,031,716	B2	4/2006	Wong
7,200,406	B2	4/2007	Wong
7,209,748	B2	4/2007	Wong
7,212,825	B2	5/2007	Wong

## FOREIGN PATENT DOCUMENTS

EP	0 344 624	A2	6/1989
EP	0 344 624	A3	6/1989
EP	0 522 772	A2	1/1993
EP	0 544 457	A2	6/1993
EP	0 553 952	A1	8/1993
JP	58-088938		5/1983
JP	05-63623		3/1993
JP	05-136823		6/1993
JP	06-77963		3/1994
WO	WO 92/09148		5/1992
WO	WO 92/17956		10/1992
WO	WO 94/09597		4/1994
WO	WO 94/24786		10/1994

## OTHER PUBLICATIONS

Draft Recommendation GSM 04.08—"Mobile Radio Interface Layer 3 Specification," Version 1.0.0, Nov. 1987.

Draft Recommendation GSM 05.02—"European digital cellular telecommunications system (phase 1); Multiplexing and Multiple Access on the Radio Path," European Telecommunications Standards Institute, Feb. 1992.

Recommendation GSM 04.07—"Mobile Radio Interface Signalling Layer 3—General Aspects," v.3.3.2, Jan. 1990.

GSM 04.07 Version 3.3.3—"Mobile Radio Interface Signalling Layer 3—General Aspects," Technical Specification, European Telecommunications Standards Institute, Feb. 1992.

Recommendation GSM 04.08, v. 3.13.0, "European digital cellular telecommunications system (phase 1); Mobile radio interface layer 3 specification," Interim European Telecommunication Standard—2<sup>nd</sup> Final Draft, pr I-ETS 300 022, Feb. 1992.

Draft Status Report—Draft Recommendation GSM 04.08 v.1.0.0, Dec. 7-10, 1987.

GSM doc (87) 143—"Status Report of WP3," Dec. 10, 1987, pp. 1-6. Exhibit A—Samsung Telecommunications America's First Supplemental Invalidation Contentions—Claim Chart—Mobitex Interface Specification (Mobitex) Against the Asserted Claim of the '406 Patent.

Exhibit B—Samsung Telecommunications America's First Supplemental Invalidation Contentions—Claim Chart—U.S. Patent No. 5,103,445 (Ostlund) Against the Asserted Claim of the '406 Patent. Kong, I., Lindsey, L., "CableNet: A Local Area Network Reservation System," 24<sup>th</sup> IEEE Computer Society International Conference, Feb. 22-25, 1982, pp. 182-186.

Mouly, Michel, et al., The GSM System for Mobile Communications, Cell & Sys., 1992, pp. 46-47, 66-67, 90-91, 94-97, 192-193, 196-197, 320-323, 354-355, 366-369, 372-379, 384-385, 388-391, 424-427.

Bertsekas, Dimitri, et al., "Data Networks," pp. 312-317 (Prentice-Hall, Inc., Upper Saddle River, New Jersey 07458, 2<sup>nd</sup> ed. 1992).

Mouly, Michel, et al., The GSM System for Mobile Communications, Cell & Sys., 1992, pp. 45, 186-259, 272-278, 396-412.

ETSI STC SMG3/SMG4 (Telia Research): "GPRS—A Proposal Based on Packet Radio". SMG4, Tdoc 49, 1994.

Defendants' Preliminary Invalidation Contentions filed Feb. 15, 2012 in *GPNE Corp. v. Amazon.com, Inc., et al.*—against the asserted claims of U.S. Patent Nos. 7,555,267, 7,570,954, and 7,792,492.

Exhibit A1 to Defendants' Preliminary Invalidation Contentions—Invalidity Chart for U.S. Patent No. 7,555,267 based on U.S. Patent No. 5,555,266 ("Buchholz") in view of U.S. Patent No. 5,465,401 ("Thompson").

Exhibit A2 to Defendants' Preliminary Invalidation Contentions—Invalidity Chart for U.S. Patent No. 7,555,267 based on Terminal Access Control System (TACS).

Exhibit A3 to Defendants' Preliminary Invalidation Contentions—Invalidity Chart for U.S. Patent No. 7,555,267 based on GSM Standard. Exhibit A4 to Defendants' Preliminary Invalidation Contentions—Invalidity Chart for U.S. Patent No. 7,555,267 based on PCT Application WO 94/09597 to Talaro ("Talaro PCT Application").

Exhibit A5 to Defendants' Preliminary Invalidation Contentions—Invalidity Chart for U.S. Patent No. 7,555,267 based on U.S. Patent No. 5,420,851 to Seshadri ("Seshadri").

Exhibit A6 to Defendants' Preliminary Invalidation Contentions—Invalidity Chart for U.S. Patent No. 7,555,267 based on U.S. Patent No. 5,717,688 to Belanger ("Belanger").

Exhibit A7 to Defendants' Preliminary Invalidation Contentions—Invalidity Chart for U.S. Patent No. 7,555,267 based on U.S. Patent No. 5,134,615 to Freeburg ("Freeburg").

Exhibit A8 to Defendants' Preliminary Invalidation Contentions—Invalidity Chart for U.S. Patent No. 7,555,267 based on U.S. Patent No. 5,142,533 to Crisler ("Crisler").

Exhibit A9 to Defendants' Preliminary Invalidation Contentions—Invalidity Chart for U.S. Patent No. 7,555,267 based on U.S. Patent No. 5,373,503 to Chen ("Chen").

Exhibit A10 to Defendants' Preliminary Invalidation Contentions—Invalidity Chart for U.S. Patent No. 7,555,267 based on U.S. Patent No. 5,603,081 to Raith ("Raith").

Exhibit A11 to Defendants' Preliminary Invalidation Contentions—Invalidity Chart for U.S. Patent No. 7,555,267 based on U.S. Patent No. 4,736,371 ("Tejima").

Exhibit A12 to Defendants' Preliminary Invalidation Contentions—Invalidity Chart for U.S. Patent No. 7,555,267 based on U.S. Patent No. 5,239,677 to Jasinski ("Jasinski").

Exhibit A13 to Defendants' Preliminary Invalidation Contentions—Invalidity Chart for U.S. Patent No. 7,555,267 based on U.S. Patent No. 5,299,198 to Kay ("198 patent").

Exhibit A14 to Defendants' Preliminary Invalidation Contentions—Invalidity Chart for U.S. Patent No. 7,555,267 based on U.S. Patent No. 4,815,073 ("073 Patent").

Exhibit A15 to Defendants' Preliminary Invalidation Contentions—Invalidity Chart for U.S. Patent No. 7,555,267 based on U.S. Patent No. 5,677,909 to Heidi ("909 Heidi Patent").

Exhibit A16 to Defendants' Preliminary Invalidation Contentions—Invalidity Chart for U.S. Patent No. 7,555,267 based on U.S. Patent No. 5,422,656 to Allard ("Allard").

Exhibit A17 to Defendants' Preliminary Invalidation Contentions—Invalidity Chart for U.S. Patent No. 7,555,267 based on U.S. Patent No. 5,210,771 to Schaeffer ("Schaeffer").

Exhibit A18 to Defendants' Preliminary Invalidation Contentions—Invalidity Chart for U.S. Patent No. 7,555,267 based on U.S. Patent No. 5,068,916 ("Harrison").

Exhibit A19 to Defendants' Preliminary Invalidation Contentions—Invalidity Chart for U.S. Patent No. 7,555,267 based on the Nokia 2110 operated on a GSM network.

Exhibit A20 to Defendants' Preliminary Invalidation Contentions—Invalidity Chart for U.S. Patent No. 7,555,267 based on U.S. Patent No. 5,172,375 ("Kou") in view of U.S. Patent No. 5,197,125 ("Engel").

Exhibit A21 to Defendants' Preliminary Invalidation Contentions—Invalidity Chart for U.S. Patent No. 7,555,267 based on U.S. Patent No. 4,736,371 ("Tejima") in view of U.S. Patent No. 5,197,125 ("Engel").

Exhibit A22 to Defendants' Preliminary Invalidation Contentions—Invalidity Chart for U.S. Patent No. 7,555,267 based on U.S. Patent No. 5,363,374 ("Abedeon") in view of U.S. Patent No. 5,197,125 ("Engel").

Exhibit A23 to Defendants' Preliminary Invalidation Contentions—Invalidity Chart for U.S. Patent No. 7,555,267 based on U.S. Patent No. 5,303,393 ("Noreen").

Exhibit B1 to Defendants' Preliminary Invalidation Contentions—Invalidity Chart for U.S. Patent No. 7,570,954 based on U.S. Patent No. 5,555,266 ("Buchholz") in view of U.S. Patent No. 5,197,125 ("Engel"), U.S. Patent No. 5,297,143 ("Fridrich"), and U.S. Patent No. 5,465,401 ("Thompson").

Exhibit B2 to Defendants' Preliminary Invalidation Contentions—Invalidity Chart for U.S. Patent No. 7,570,954 based on Terminal Access Control System (TACS).

- Exhibit B3 to Defendants' Preliminary Invalidation Contentions—Invalidity Chart for U.S. Patent No. 7,570,954 based on GSM Standard.
- Exhibit B4 to Defendants' Preliminary Invalidation Contentions—Invalidity Chart for U.S. Patent No. 7,570,954 based on PCT Talaro Application.
- Exhibit B5 to Defendants' Preliminary Invalidation Contentions—Invalidity Chart for U.S. Patent No. 7,570,954 based on U.S. Patent No. 5,420,851 to Seshadri ("Seshadri").
- Exhibit B6 to Defendants' Preliminary Invalidation Contentions—Invalidity Chart for U.S. Patent No. 7,570,954 based on U.S. Patent No. 5,717,688 to Belanger ("Belanger").
- Exhibit B7 to Defendants' Preliminary Invalidation Contentions—Invalidity Chart for U.S. Patent No. 7,570,954 based on U.S. Patent No. 5,134,615 to Freeburg ("Freeburg").
- Exhibit B8 to Defendants' Preliminary Invalidation Contentions—Invalidity Chart for U.S. Patent No. 7,570,954 based on U.S. Patent No. 5,142,533 to Crisler ("Crisler").
- Exhibit B9 to Defendants' Preliminary Invalidation Contentions—Invalidity Chart for U.S. Patent No. 7,570,954 based on U.S. Patent No. 5,373,503 to Chen ("Chen").
- Exhibit B10 to Defendants' Preliminary Invalidation Contentions—Invalidity Chart for U.S. Patent No. 7,570,954 based on U.S. Patent No. 5,603,081 to Raith ("Raith").
- Exhibit B11 to Defendants' Preliminary Invalidation Contentions—Invalidity Chart for U.S. Patent No. 7,570,954 based on U.S. Patent No. 4,736,371 ("Tejima").
- Exhibit B12 to Defendants' Preliminary Invalidation Contentions—Invalidity Chart for U.S. Patent No. 7,570,954 based on U.S. Patent No. 5,239,677 to Jasinski ("Jasinski").
- Exhibit B13 to Defendants' Preliminary Invalidation Contentions—Invalidity Chart for U.S. Patent No. 7,570,954 based on U.S. Patent No. 5,299,198 to Kay ("198 patent").
- Exhibit B14 to Defendants' Preliminary Invalidation Contentions—Invalidity Chart for U.S. Patent No. 7,570,954 based on the Mobitex Interface Specification.
- Exhibit B15 to Defendants' Preliminary Invalidation Contentions—Invalidity Chart for U.S. Patent No. 7,570,954 based on the AMPS System.
- Exhibit B16 to Defendants' Preliminary Invalidation Contentions—Invalidity Chart for U.S. Patent No. 7,570,954 based on U.S. Patent No. 4,815,073 ("The '073 Patent").
- Exhibit B17 to Defendants' Preliminary Invalidation Contentions—Invalidity Chart for U.S. Patent No. 7,570,954 based on U.S. Patent No. 5,677,909 to Heidi ("909 Heidi Patent").
- Exhibit B18 to Defendants' Preliminary Invalidation Contentions—Invalidity Chart for U.S. Patent No. 7,570,954 based on U.S. Patent No. 5,422,656 to Allard ("Allard").
- Exhibit B19 to Defendants' Preliminary Invalidation Contentions—Invalidity Chart for U.S. Patent No. 7,570,954 based on U.S. Patent No. 5,210,771 to Schaeffer ("Schaeffer").
- Exhibit B20 to Defendants' Preliminary Invalidation Contentions—Invalidity Chart for U.S. Patent No. 7,570,954 based on U.S. Patent No. 5,068,916 ("Harrison").
- Exhibit B21 to Defendants' Preliminary Invalidation Contentions—Invalidity Chart for U.S. Patent No. 7,570,954 based on the Nokia 2110 operated on a GSM network.
- Exhibit B22 to Defendants' Preliminary Invalidation Contentions—Invalidity Chart for U.S. Patent No. 7,570,954 based on U.S. Patent No. 5,172,375 ("Kou") in view of U.S. Patent No. 5,197,125 ("Engel").
- Exhibit B23 to Defendants' Preliminary Invalidation Contentions—Invalidity Chart for U.S. Patent No. 7,570,954 based on U.S. Patent No. 5,363,374 ("Aberdeen") in view of U.S. Patent No. 5,197,125 ("Engel").
- Exhibit B24 to Defendants' Preliminary Invalidation Contentions—Invalidity Chart for U.S. Patent No. 7,570,954 based on U.S. Patent No. 4,736,371 ("Tejima") in view of U.S. Patent No. 5,197,125 ("Engel").
- Exhibit B25 to Defendants' Preliminary Invalidation Contentions—Invalidity Chart for U.S. Patent No. 7,570,954 based on U.S. Patent No. 5,303,393 ("Noreen").
- Exhibit C1 to Defendants' Preliminary Invalidation Contentions—Invalidity Chart for U.S. Patent No. 7,792,492 based on U.S. Patent No. 5,555,266 ("Buchholz") in view of U.S. Patent No. 5,197,125 ("Engel"), U.S. Patent No. 5,465,401 ("Thompson"), Terminal Access Control System (TACS).
- Exhibit C2 to Defendants' Preliminary Invalidation Contentions—Invalidity Chart for U.S. Patent No. 7,792,492 based on Terminal Access Control System (TACS).
- Exhibit C3 to Defendants' Preliminary Invalidation Contentions—Invalidity Chart for U.S. Patent No. 7,792,492 based on GSM Standard.
- Exhibit C4 to Defendants' Preliminary Invalidation Contentions—Invalidity Chart for U.S. Patent No. 7,792,492 based on PCT Talaro Application.
- Exhibit C5 to Defendants' Preliminary Invalidation Contentions—Invalidity Chart for U.S. Patent No. 7,792,492 based on U.S. Patent No. 5,717,688 to Belanger ("Belanger").
- Exhibit C6 to Defendants' Preliminary Invalidation Contentions—Invalidity Chart for U.S. Patent No. 7,792,492 based on U.S. Patent No. 5,134,615 to Freeburg ("Freeburg").
- Exhibit C7 to Defendants' Preliminary Invalidation Contentions—Invalidity Chart for U.S. Patent No. 7,792,492 based on U.S. Patent No. 5,142,533 to Crisler ("Crisler").
- Exhibit C8 to Defendants' Preliminary Invalidation Contentions—Invalidity Chart for U.S. Patent No. 7,792,492 based on U.S. Patent No. 5,373,503 to Chen ("Chen").
- Exhibit C9 to Defendants' Preliminary Invalidation Contentions—Invalidity Chart for U.S. Patent No. 7,792,492 based on U.S. Patent No. 5,603,081 to Raith ("Raith").
- Exhibit C10 to Defendants' Preliminary Invalidation Contentions—Invalidity Chart for U.S. Patent No. 7,792,492 based on U.S. Patent No. 4,736,371 ("Tejima").
- Exhibit C11 to Defendants' Preliminary Invalidation Contentions—Invalidity Chart for U.S. Patent No. 7,792,492 based on U.S. Patent No. 5,239,677 to Jasinski ("Jasinski").
- Exhibit C12 to Defendants' Preliminary Invalidation Contentions—Invalidity Chart for U.S. Patent No. 7,792,492 based on U.S. Patent No. 5,299,198 to Kay ("198 Patent").
- Exhibit C13 to Defendants' Preliminary Invalidation Contentions—Invalidity Chart for U.S. Patent No. 7,792,492 based on U.S. Patent No. 5,420,851 to Seshadri ("Seshadri").
- Exhibit C14 to Defendants' Preliminary Invalidation Contentions—Invalidity Chart for U.S. Patent No. 7,792,492 based on U.S. Patent No. 4,815,073 ("073 Patent").
- Exhibit C15 to Defendants' Preliminary Invalidation Contentions—Invalidity Chart for U.S. Patent No. 7,792,492 based on U.S. Patent No. 5,677,909 to Heidi ("909 Heidi Patent").
- Exhibit C16 to Defendants' Preliminary Invalidation Contentions—Invalidity Chart for U.S. Patent No. 7,792,492 based on U.S. Patent No. 5,422,656 to Allard ("Allard").
- Exhibit C17 to Defendants' Preliminary Invalidation Contentions—Invalidity Chart for U.S. Patent No. 7,792,492 based on U.S. Patent No. 5,210,771 to Schaeffer ("Schaeffer").
- Exhibit C18 to Defendants' Preliminary Invalidation Contentions—Invalidity Chart for U.S. Patent No. 7,792,492 based on U.S. Patent No. 5,068,916 ("Harrison").
- Exhibit C19 to Defendants' Preliminary Invalidation Contentions—Invalidity Chart for U.S. Patent No. 7,792,492 based on the Nokia 2110 operated on a GSM network.
- Exhibit C20 to Defendants' Preliminary Invalidation Contentions—Invalidity Chart for U.S. Patent No. 7,792,492 based on U.S. Patent No. 5,172,375 ("Kou") in view of U.S. Patent No. 5,197,125 ("Engel").
- Exhibit C21 to Defendants' Preliminary Invalidation Contentions—Invalidity Chart for U.S. Patent No. 7,792,492 based on U.S. Patent No. 4,736,371 ("Tejima") in view of U.S. Patent No. 5,197,125 ("Engel").
- Exhibit C22 to Defendants' Preliminary Invalidation Contentions—Invalidity Chart for U.S. Patent No. 7,792,492 based on U.S. Patent No. 5,363,374 ("Abdeen") in view of U.S. Patent No. 5,197,125 ("Engel").
- Exhibit C23 to Defendants' Preliminary Invalidation Contentions—Invalidity Chart for U.S. Patent No. 7,792,492 based on U.S. Patent No. 5,303,393 ("Noreen").

- European digital cellular telecommunications system (phase 1); Multiplexing and multiple access on the radio path, I-ETS 300 030, European Telecommunications Standards Institute, May 1992.
- European digital cellular telecommunications system (phase 1); Radio transmission and reception, IETS 300 033, European Telecommunications Standards Institute, May 1992.
- Nokia 2110 User's guide, Issue 5, 1993.
- Imamura, Kenji, et al., "Mobile Communication Control using Multi-transmitter Simul/Sequential Casting (MSSC)," 1986 IEEE.
- GSM 04.05 Version 3.1.5—"MS—BSS Data Link Layer—General Aspects," European Telecommunications Standards Institute, Feb. 1992.
- GSM 04.06 Version 3.9.0—"MS—BSS Interface Data Link Layer Specification," European Telecommunications Standards Institute, Feb. 1992.
- GSM 04.11 Version 3.3.0—"Point-to-Point Short Message Service Support on Mobile Radio Interface," European Telecommunications Standards Institute, Jan. 1993.
- GSM 05.01 Version 3.3.2—"Physical Layer on the Radio Path: General Description," European Telecommunications Standards Institute, Feb. 1992.
- GSM 05.02 Version 3.8.0—"Multiplexing and Multiple Access on the Radio Path," European Telecommunications Standards Institute, Dec. 1995.
- GSM 02.03 Version 3.4.0—"TeleServices Supported by a GSM PLMN," European Telecommunications Standards Institute, Feb. 1992.
- GSM 03.09 Version 3.2.1—"Handover Procedures," European Telecommunications Standards Institute, Feb. 1992.
- Engel, G.M., et al., "Multiple Channel Demand Assignment Multiple Access (DAMA) System Design for UHF MILSATCOM," M/A-COM Government Systems, Inc., American Institute of Aeronautics and Astronautics, Inc., 1989.
- Taylor, L.E., "Terminal Access Control System (TACS) Circuit Allocation," Project Report NSP-4, M.I.T. Lincoln Laboratory, May 8, 1978.
- Taylor, Lee.E., et al., "TACS—A Demand Assignment System for FLEETSAT," IEEE Transactions on Communications, vol. COM-27, No. 10, Oct. 1979.
- Bridwell, J.D., "A Terminal Access Control System for FLEETSAT," M.I.T. Lincoln Laboratory, Technical Note 1976-29, Nov. 22, 1976.
- Bridwell, J.D., et al., "A Preliminary Design of a TDMA System for FLEETSAT," M.I.T. Lincoln Laboratory, Technical Note 1975-5, Mar. 12, 1975.
- Panzer, Herbert, et al., "Adaptive Resource Allocation in Metropolitan Area Cellular Mobile Radio Systems," 1990 IEEE.
- Zhang, Ming, et al., "Comparisons of Channel-Assignment Strategies in Cellular Mobile Telephone Systems," IEEE Transactions on Vehicular Technology, vol. 38, No. 4, Nov. 1989.
- Onoe, Seizo, et al., "Control Channel Structure for TDMA Mobile Radio Systems," 1990 IEEE.
- Fraser, Robert, "The Mobitex Terminal Specification: Evolution, administration and guided tour," Communications, Jul.-Aug. 1991.
- Goodman, David, "Trends in Cellular and Cordless Communications," IEEE Communications Magazine, Jun. 1991.
- Okada, Kazunori, et al., "On Dynamic Channel Assignment in Cellular Mobile Radio Systems," IEEE Apr. 1991.
- Umeda, Narumi, et al., "Design and Performance Evaluation of Novel Common Control Channels for Digital Mobile Radio," IEEE 1991.
- Walke, B., et al., "The Performance of Cellpac: A Packet Radio Protocol Proposed for the GSM Mobile Radio Network," MRC, Mobile Radio Conference 1991, Nov. 13-15, 1991, Acropolis, Nice, France.
- Walke, B., et al., "CELLPAC: A Packet Radio Protocol Applied to the Cellular GSM Mobile Radio Network," IEEE 1991.
- Cox, Donald, "Wireless Network Access for Personal Communications," IEEE Communications Magazine, Dec. 1992.
- Parsa, Kourosh, "The Mobitex Packet-Switched Radio Data System," IEEE 1992.
- Decker, P., et al., "A General Packet Radio Service Proposed for GSM," RWTH, Helsinki, Oct. 13, 1993.
- Decker, Peter, "Packet Radio in GSM," Dec. 2, 1993.
- Yeung, Kwan, et al., "The Optimization of Nominal Channel Allocation in Cellular Mobile Systems," IEEE 1993.
- Decker, P., "A Packet Radio Protocol Proposed for the GSM Mobile Radio Network," Proceedings Mobile Multimedia (MoMuC-1), Tokyo, Dec. 1993.
- Decker, P., "A Packet Radio Protocol for Group Communication Suitable for the GSM Mobile Radio Network," IEEE/ICCC.
- Bianchi, Giuseppe, et al., "Packet Data Service over GSM Networks: Proposal and Performance Evaluation Attempt," Milano, Italy.
- Bohmer, Stefan, "Performance Analysis of the GSM Signalling Protocol LAPD," 1994 IEEE.
- Kishi, Yohji, et al., "A Unified Approach for Frequency Assignment of Cellular Mobile Networks," IEEE Apr. 1994.
- Mitrou, N.M., et al., "A Reservation Multiple Access Protocol for Microcellular Mobile-Communication Systems," IEEE Transactions on Vehicular Technology, vol. 39, No. 4, Nov. 1990.
- Malyan, A.D., et al., "A Speech Packet Protocol for Mobile Radio Using Idle-Signal Casting Multiple Access," Third IEEE Conference on Telecommunications, Conference Publication No. 331.
- Young, W.R., "Advanced Mobile Phone Service: Introduction, Background, and Objectives," The Bell System Technical Journal, vol. 58, No. 1, Jan. 1979.
- "Cellular System Mobile Station—Land Station Compatibility Specification," OST Bulletin No. 53, Jul. 1983.
- Fluhr, Z.C., et al., "Advanced Mobile Phone Service: Control Architecture," The Bell System Technical Journal, vol. 58, No. 1, Jan. 1979.
- Chien, E.S.K., et al., "Cellular Access Digital Network (CADN): Wireless Access to Networks of the Future," IEEE Communications Magazine, vol. 25, No. 6, Jun. 1987.
- Prech, Eduardo, et al., "Cellular Models and Hand-off Criteria," IEEE 1989.
- Lam, Simon, "Data Link Control Procedures," chapter in Computer Communications, vol. 1: Principles, W. Chou (ed.), Prentice-Hall, 1982.
- Roorda, Peter, et al., "Dynamic Time Slot Assignment in Reservation Protocols for Multiaccess Channels," IEEE Pac Rim 1993.
- Research in Motion, Installation & User's Guide, "Freedom PCS Network Adapter for Mobitex," version 1.0, Oct. 13, 1995.
- Luo, Xin, et al., "Handoff Effects in Microcellular Systems," IEEE 1992.
- Karol, Mark, et al., "Improving the Performance of Input-Queued ATM Packet Switches," Infocom '92, IEEE 1992.
- Obara, Hitoshi, et al., "An Efficient Contention Resolution Algorithm for Input Queuing ATM Cross-Connect Switches," International Journal of Digital and Analog Cabled Systems, vol. 2, 261-267 (1989).
- Kleinrock, Leonard, "Performance Evaluation of Distributed Computer-Communication Systems," Computer Science Department Technical Report, UCLA, Oct. 1988.
- Khan, Mobeen, et al., "MOBITEX and Mobile Data Standards," IEEE Communications Magazine, Mar. 1995.
- MIS—Mobitex Interface Specification, Jun. 4, 2002.
- General Binder Overview, Oct. 26, 1992.
- "Mobitex Made Easy—A guide to wireless computing," Research in Motion, 1994 edition.
- Goodman, D.J., et al., "Packet Reservation Multiple Access for Local Wireless Communications," IEEE Transactions on Communications, vol. 37, No. 8, Aug. 1989.
- Cox, Donald, "Portable Digital Radio Communications—An Approach to Tetherless Access," IEEE Communications Magazine, Jul. 1989.
- Rahnema, Moe, "Overview of the GSM System and Protocol Architecture," IEEE Communications Magazine, Apr. 1993.
- Mobitex User's Handbook for the Mobidem AT, Research in Motion, Version 1.0, Apr. 1993.
- User's Handbook for Wireless Computing, Research in Motion, Version 1.1, Jun. 1993.
- RIMGate™ Gateway, Version 3.0, Installation and User's Guide, Preliminary Draft, Research in Motion, Aug. 19, 1994.
- RIMGate data sheet, Research in Motion.
- Sachs, Sonia, "Alternative Local Area Network Access Protocols," IEEE Communications Magazine, vol. 26, No. 3, Mar. 1988.

Ousterhout, John, "Scheduling Techniques for Concurrent Systems," IEEE Distributed Computer Systems, 1982.

"Bellsouth, IBM unveil personal communicator phone," Mobile Phone News, Nov. 8, 1993, [http://findarticles.com/p/articles/mi\\_m3457/is\\_n43\\_v11/ai\\_14297997/printed Jul. 25, 2009](http://findarticles.com/p/articles/mi_m3457/is_n43_v11/ai_14297997/printed Jul. 25, 2009).

"BellSouth Cellular/IBM Release Simon PDA," Telecommunications, 28(1), p. 116, Jan. 1994.

Simon Says "Here's How!", Simon User's Manual, BellSouth, IBM Corp., 1994.

"Simon says: Super-phone is giant step," USA Today.com, Nov. 3, 1993.

Lewis, James, "Reaping the Benefits of Modern Usability Evaluation: The Simon Story," IBM Human Factors Group.

Tobagi, Fouad, et al., "Packet Switching in Radio Channels: Part III—Polling and (Dynamic) Split-Channel Reservation Multiple

Access," IEEE Transactions on Communications, vol. COM-24, No. 8, Aug. 1976.

Integrated Services Digital Network (ISDN)—Overall Network Aspects and Functions, ISDN User-Network Interfaces, B-ISDN ATM Layer Specification, CCITT Recommendation 1.361, Geneva, 1991.

Cox, Donald, et al., "A Comparison of Some Channel Assignment Strategies in Large-Scale Mobile Communications Systems," IEEE Transactions on Communications, vol. COM-20, No. 2, Apr. 1972.

Okasaka, Sadaatsu, "Control Channel Traffic Design in a High-Capacity Land Mobile Telephone System," IEEE Transactions on Vehicular Technology, vol. VT-27, No. 4, Nov. 1978.

\* cited by examiner

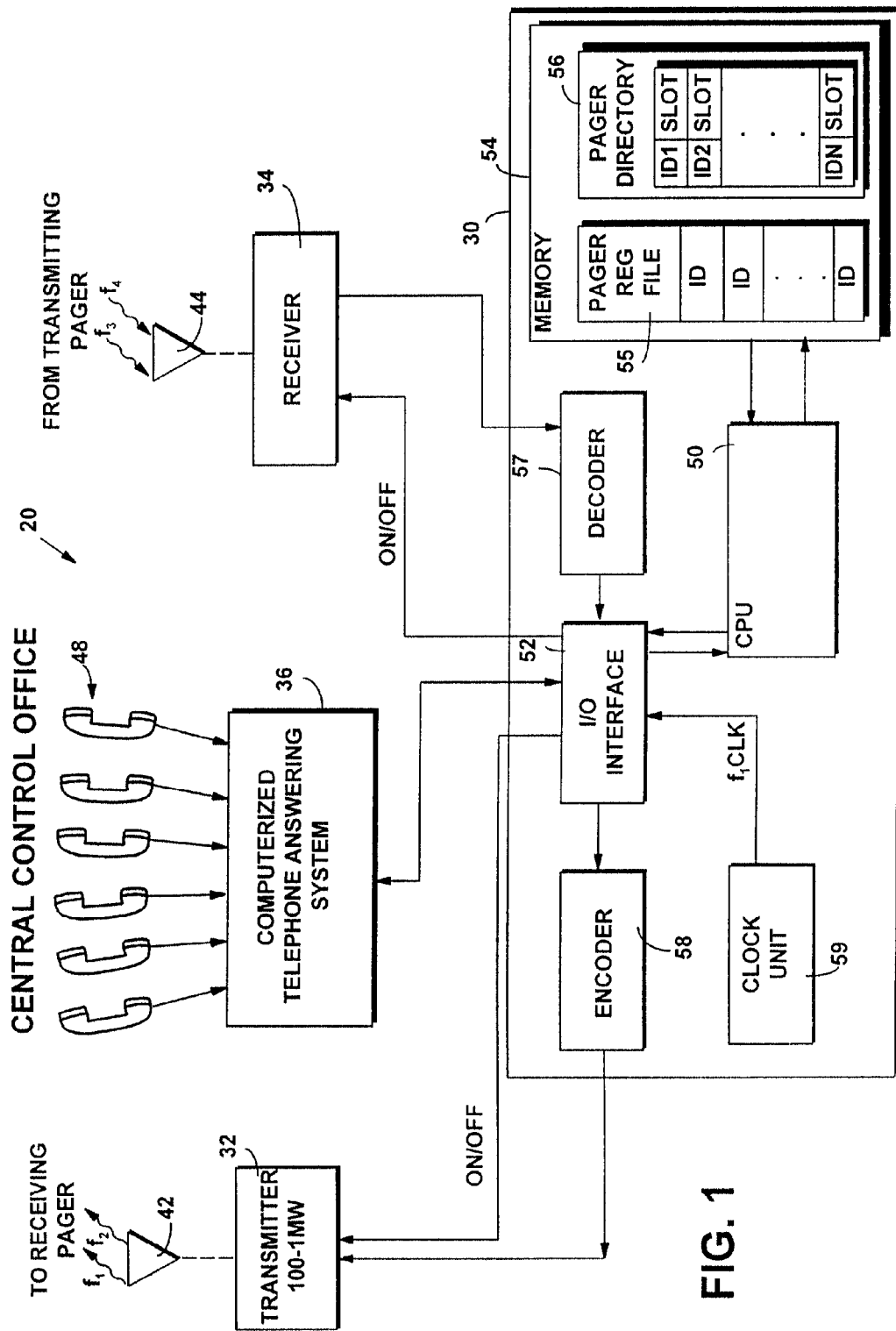

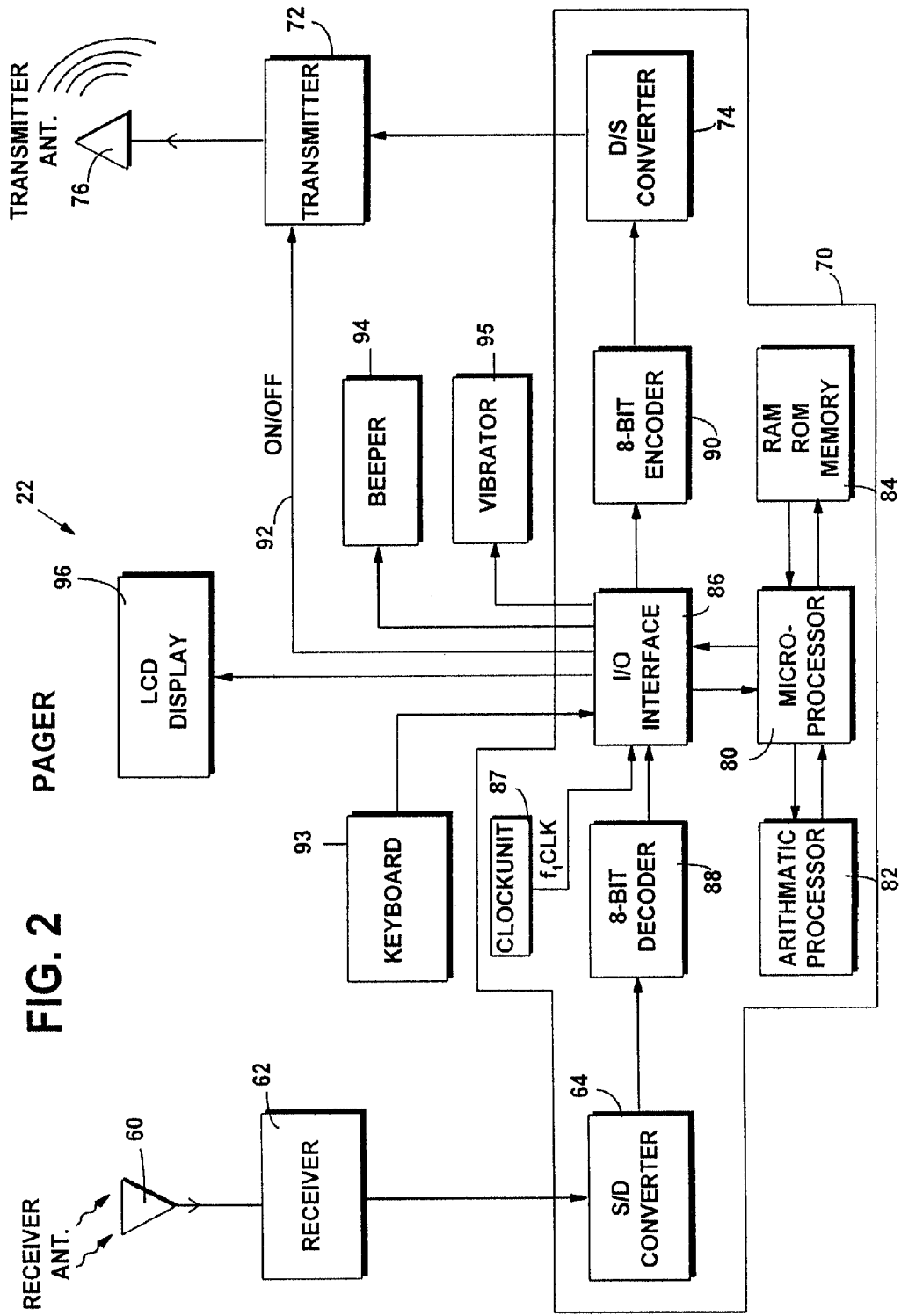
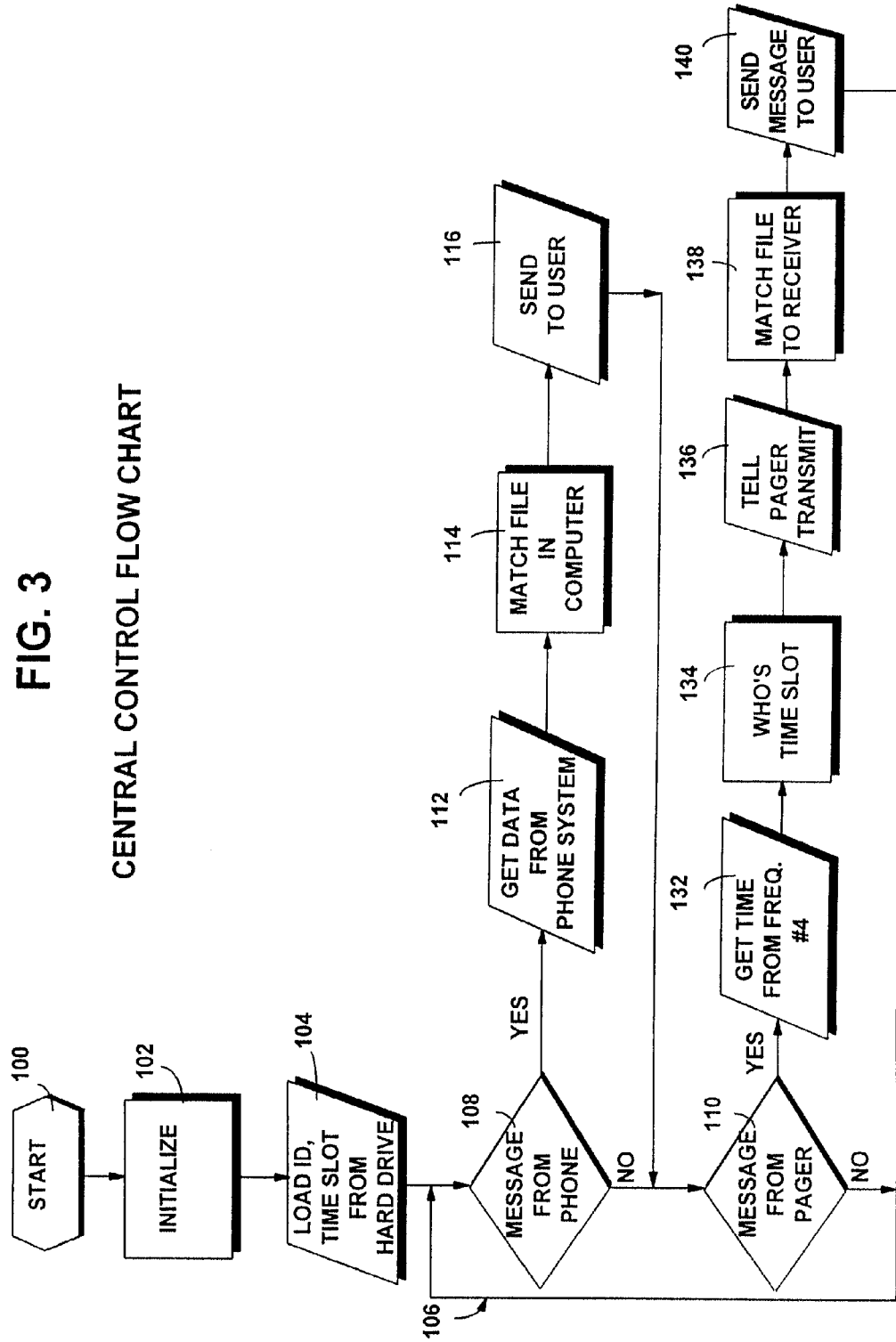

FIG. 2



FIG. 3  
CENTRAL CONTROL FLOW CHART



PAGER TRANSMITTER PROGRAM FLOW CHART

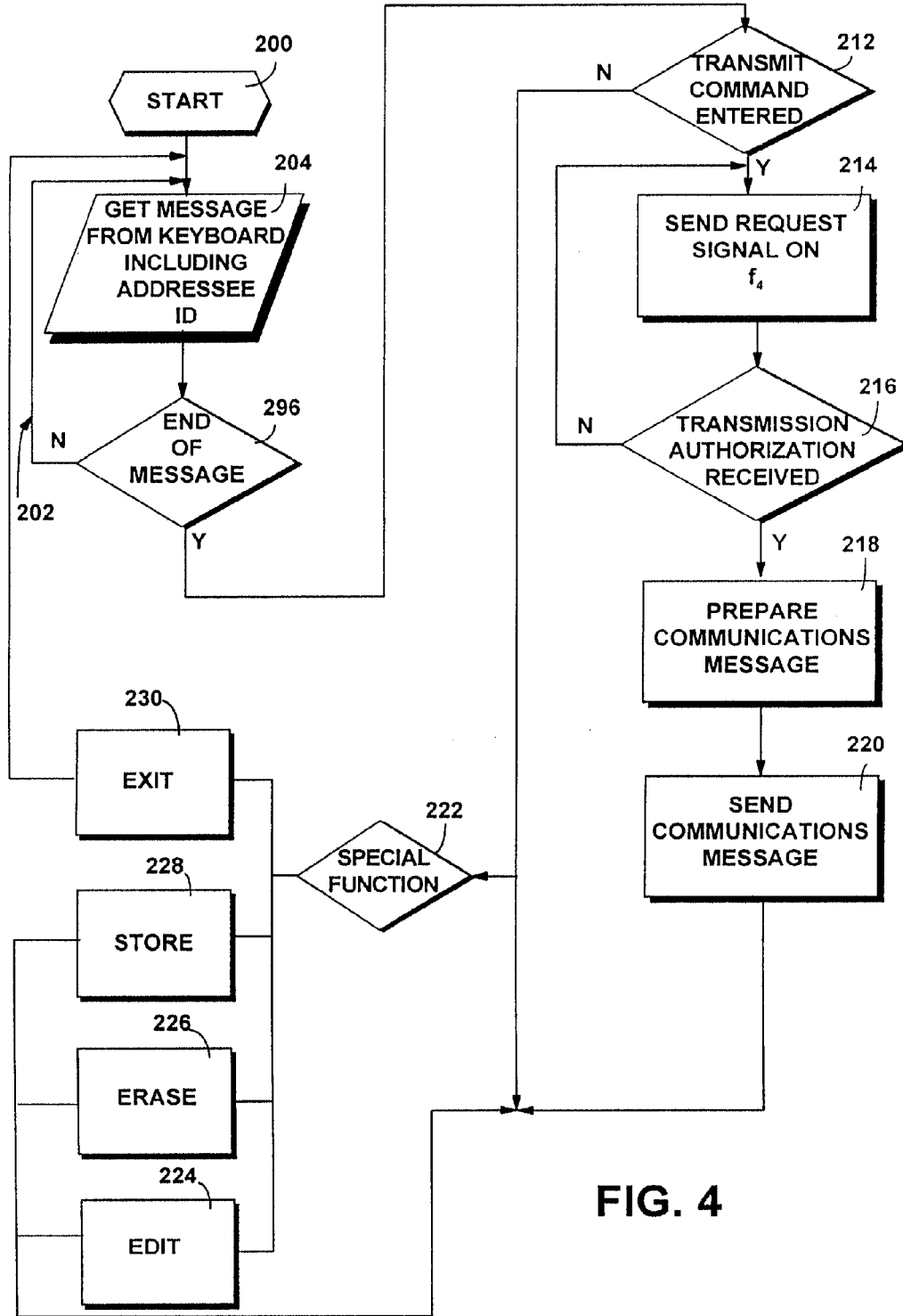

FIG. 4

FIG. 5

PAGER RECEIVER PROGRAM FLOW CHART

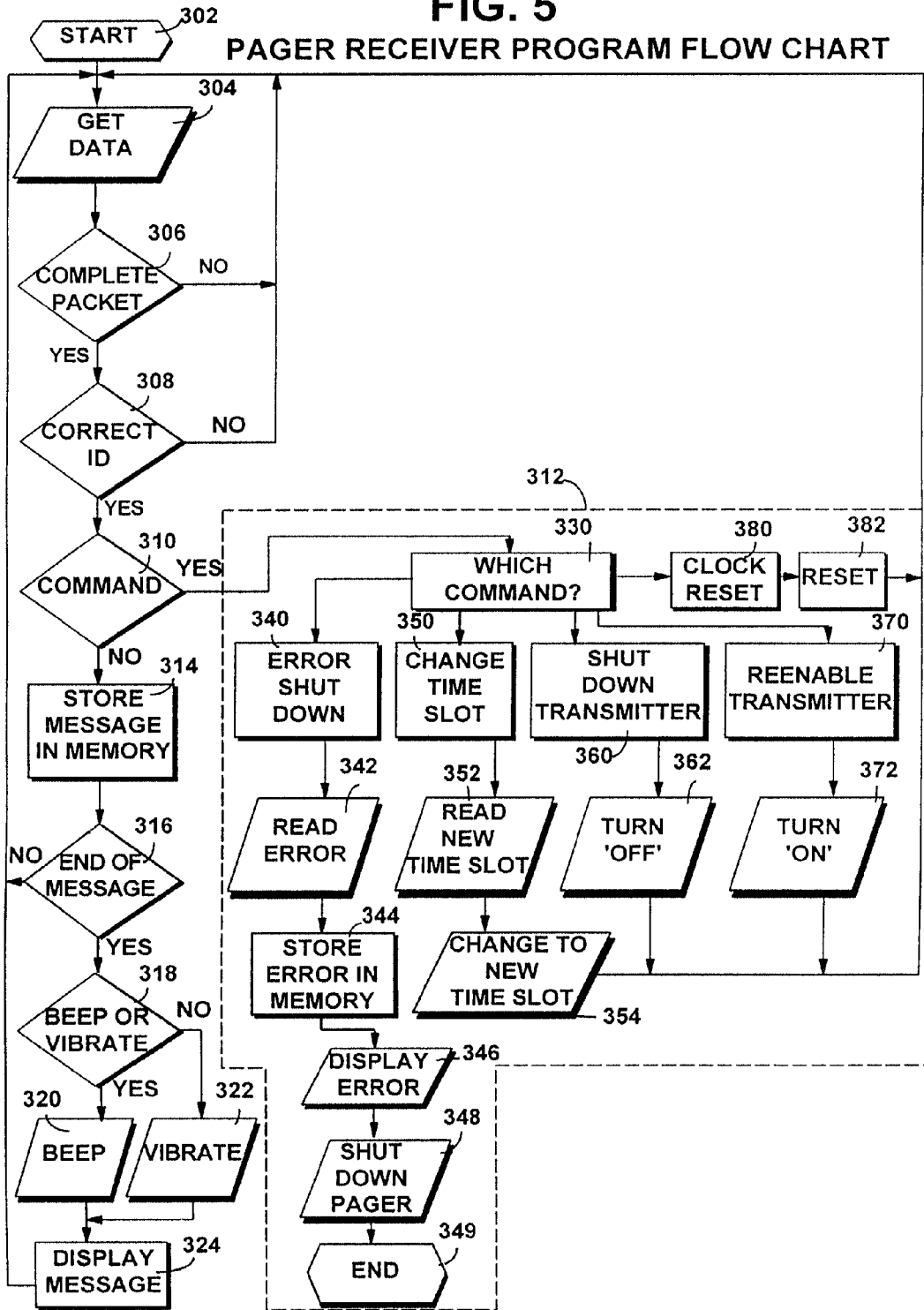
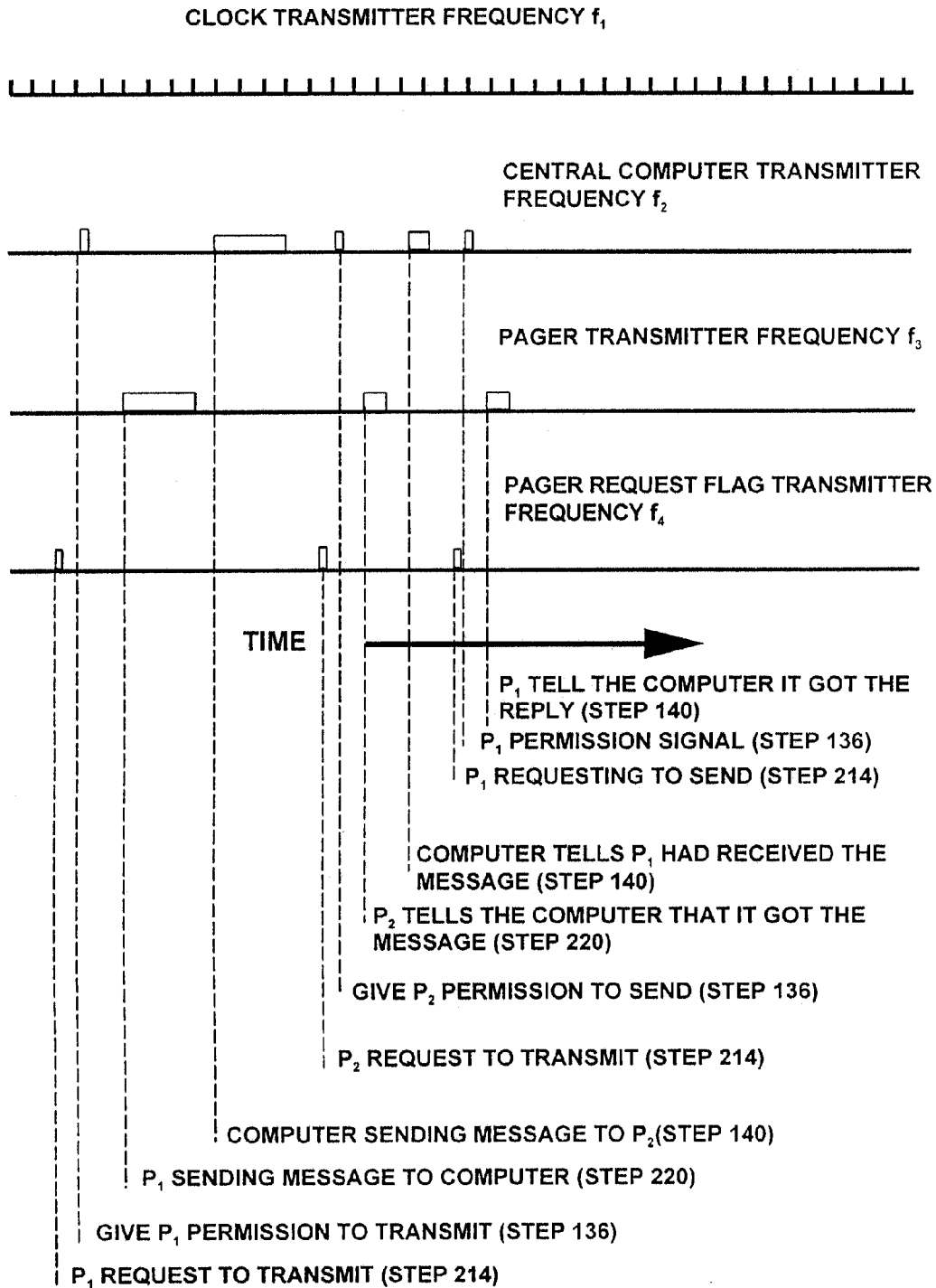
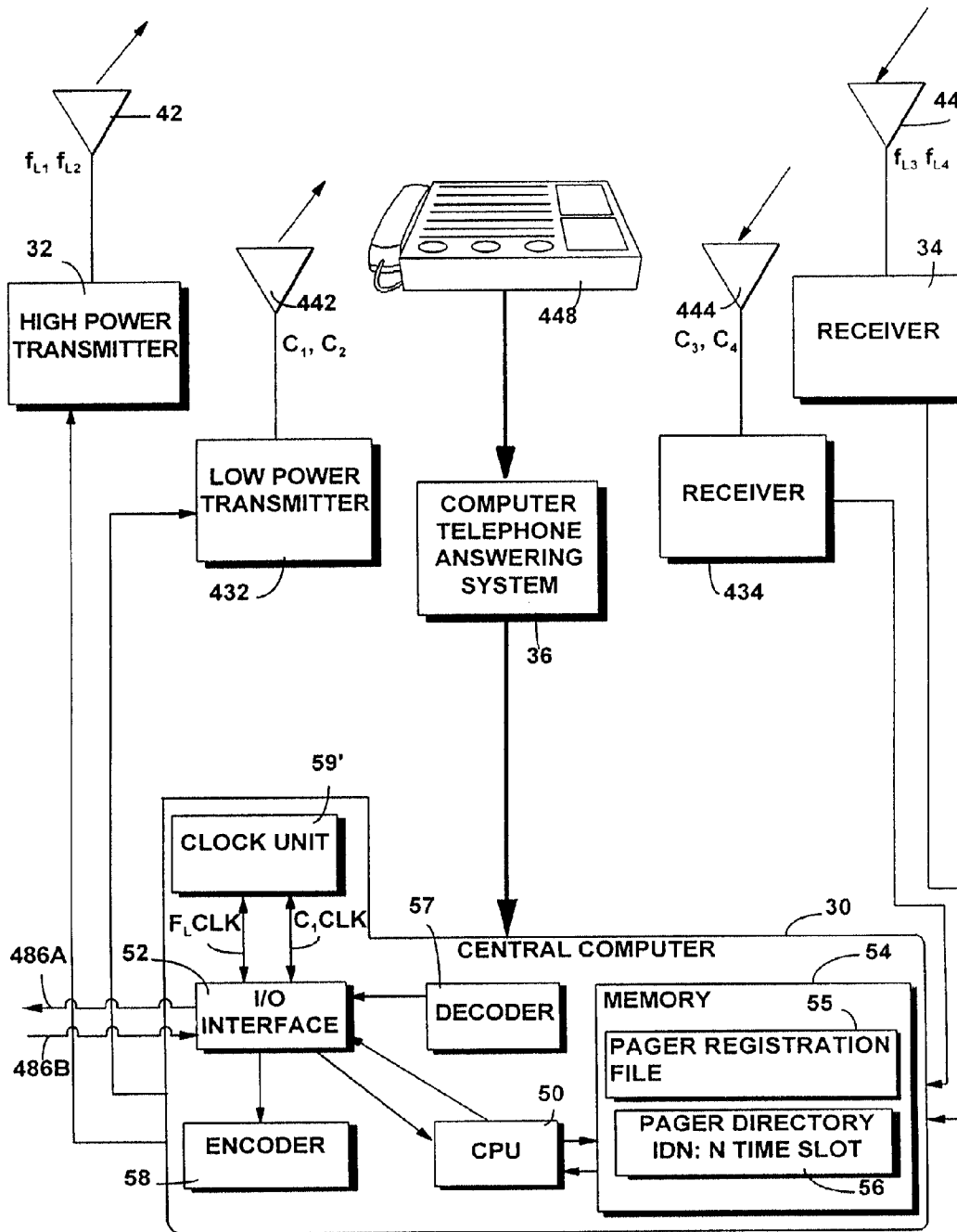

FIG. 6



**FIG. 7**  
CENTRAL OFFICE LAYOUT



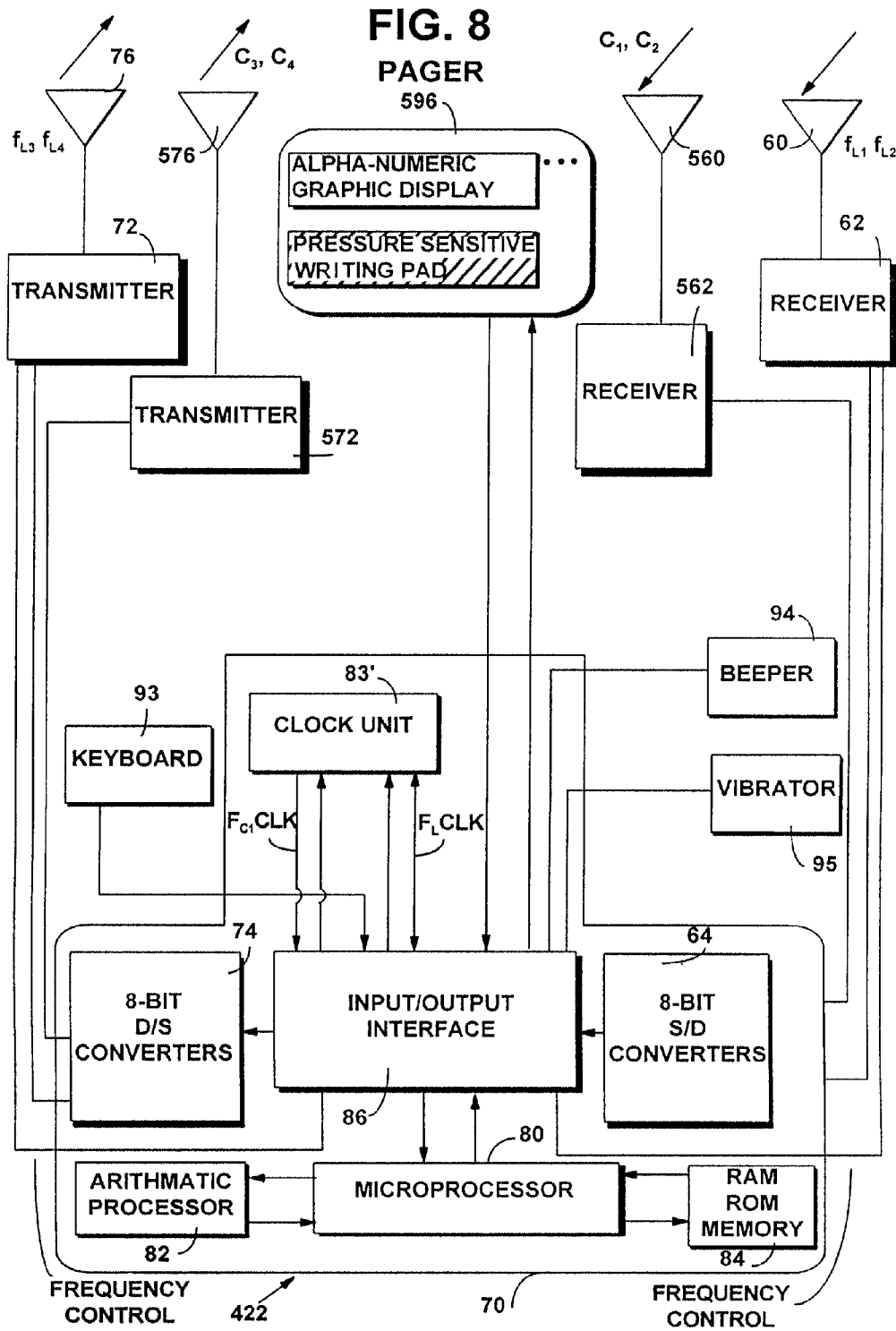
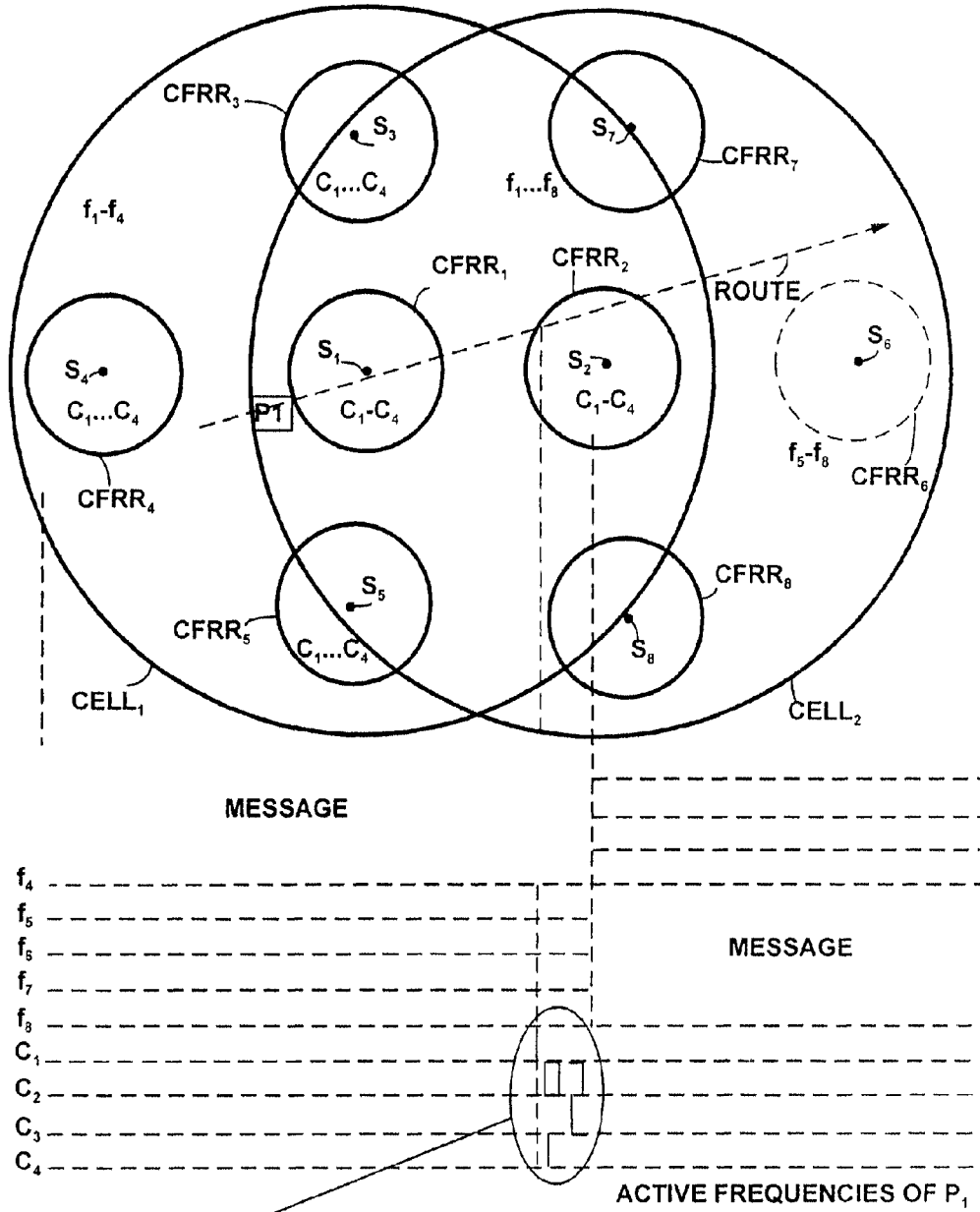

FIG. 9



- P<sub>1</sub> ALIGN ITS CLOCK WITH S<sub>2</sub> FROM C<sub>1</sub> (STEP 504)
- P<sub>1</sub> DETECTED NEW SYSTEM INFORMATION ON C<sub>2</sub> (STEP 508)
- P<sub>1</sub> REQUESTING NEW FREQUENCIES (STEP 510)
- S<sub>2</sub> TELLS PAGER TO IDENTIFY ITSELF (STEP 616)
- P<sub>1</sub> SENDS ITS ID INFORMATION ON C<sub>3</sub> (STEP 516)
- NEW TIME SLOT AND NEW FREQUENCIES
- INFORMATION GIVEN ON C<sub>2</sub> FROM S<sub>2</sub> (STEPS 632 AND 634)

### PAGER CHANNEL SWITCHING FLOW CHART

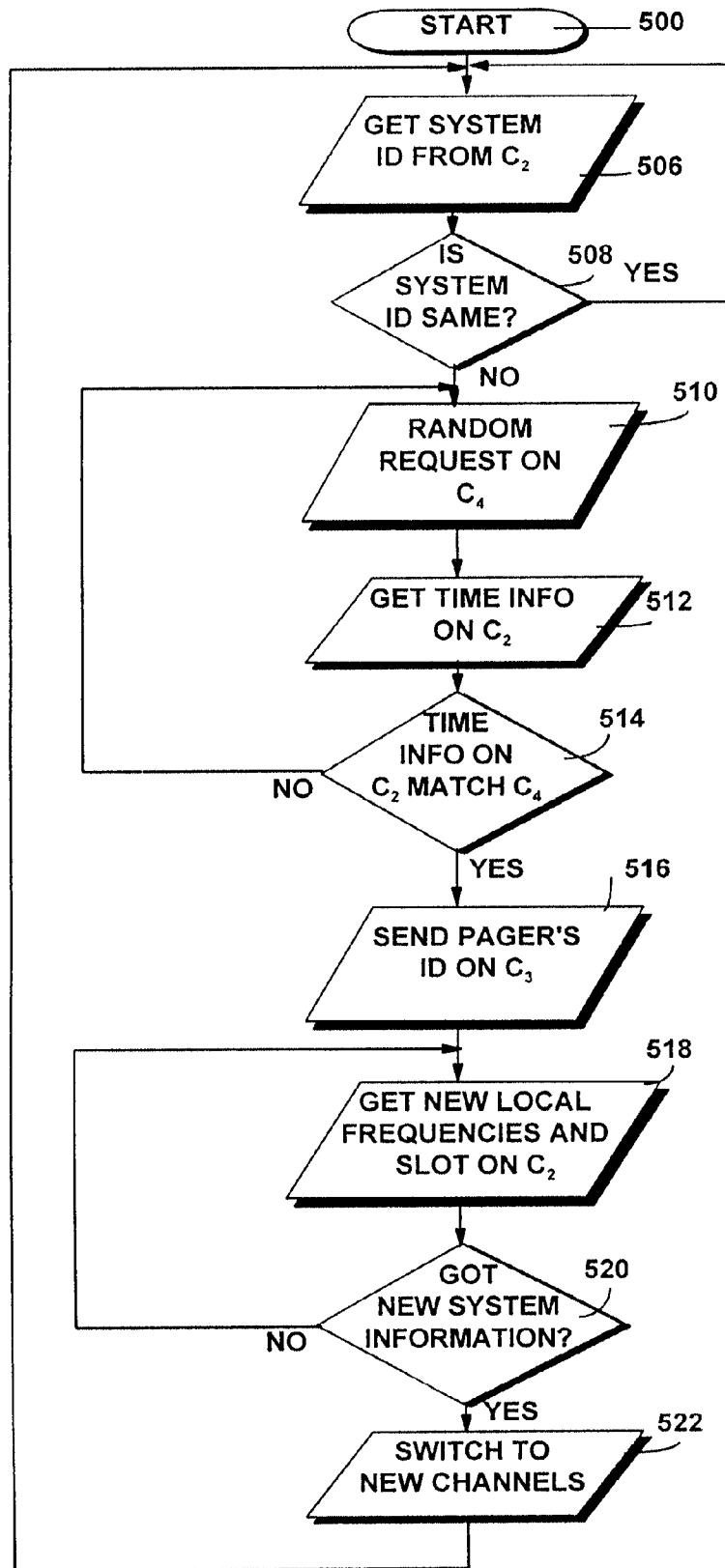

FIG. 10



FIG. 11

CENTRAL STATION SWITCHING ENABLING

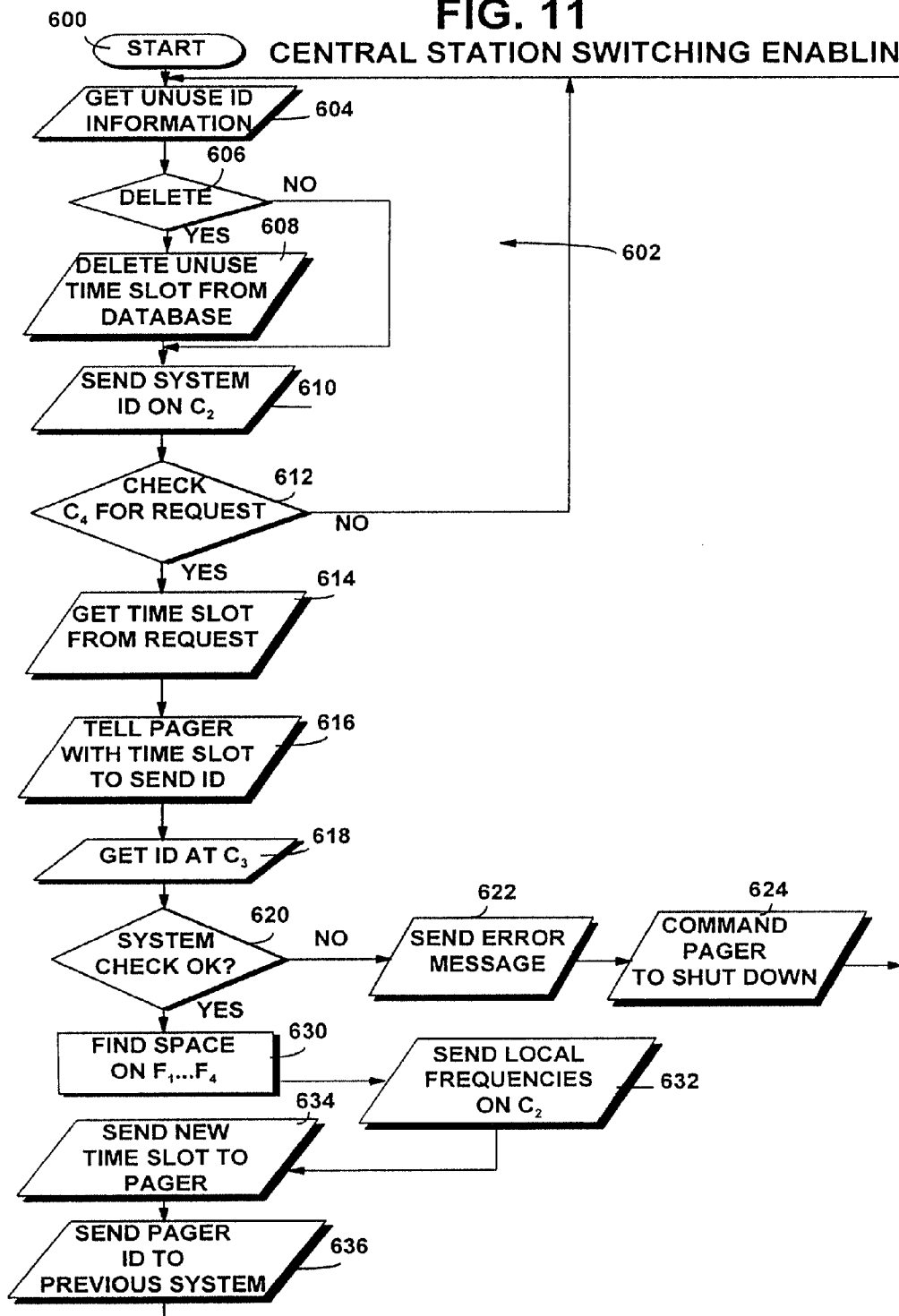

FIG. 12

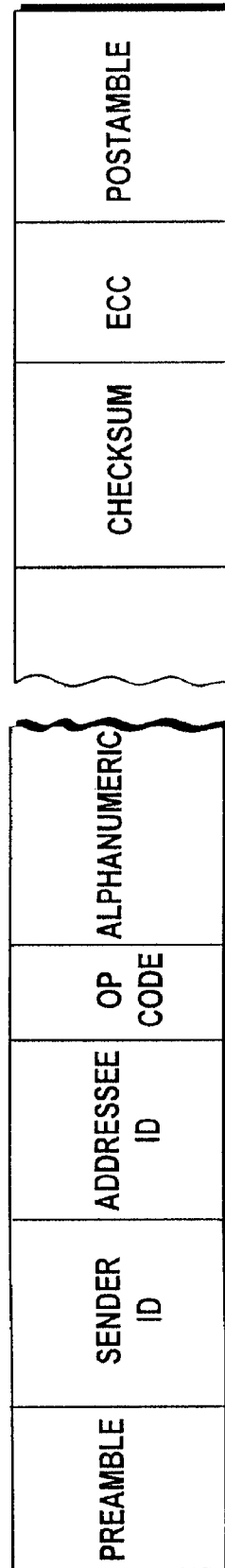
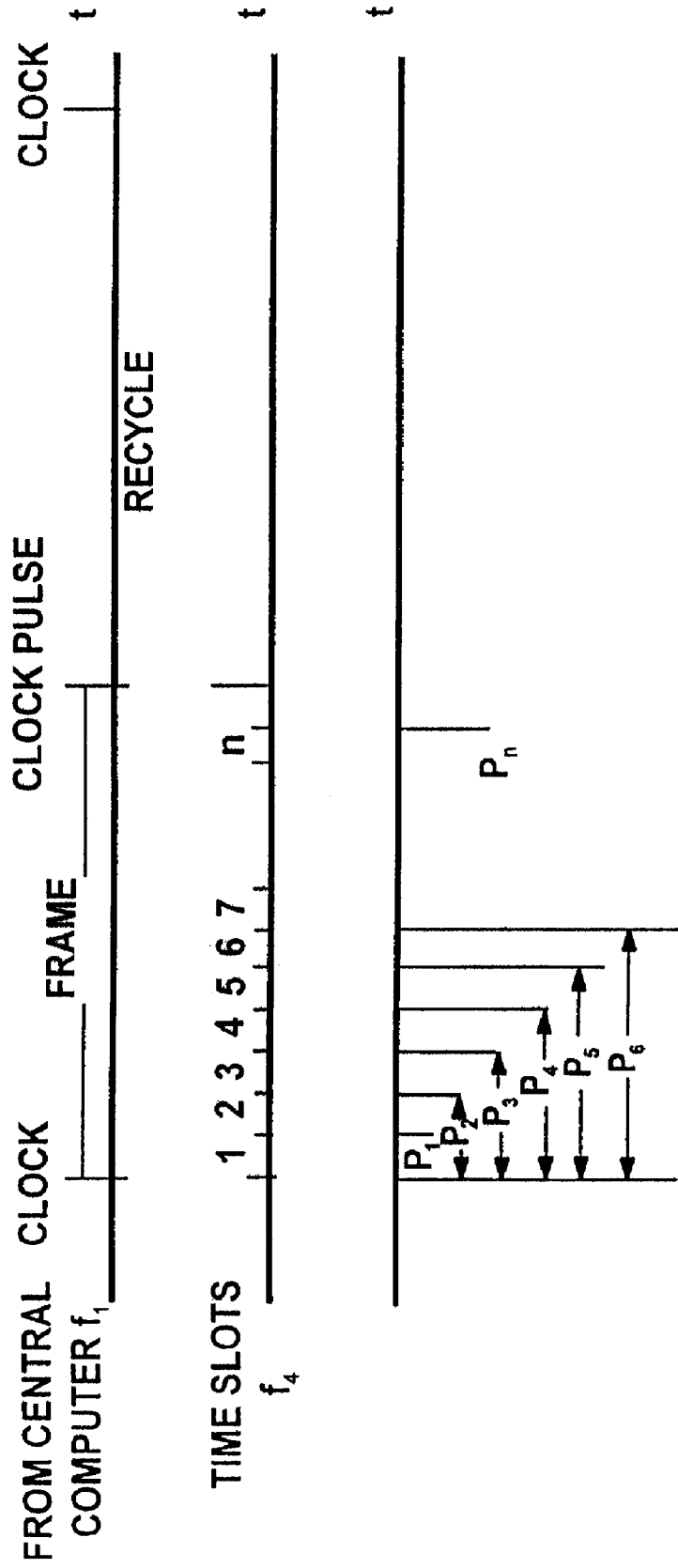

FIG. 13



**COMMUNICATION SYSTEM WITH MAP OF  
INFORMATION PROVIDED FROM  
CONTROLLER TO ENABLE  
COMMUNICATION WITH NODES**

CLAIM OF PRIORITY

This application is a continuation of U.S. patent application Ser. No. 11/668,922 filed on Jan. 30, 2007, which is a continuation of U.S. patent application Ser. No. 11/350,616 filed on Feb. 8, 2006, now U.S. Pat. No. 7,200,406, issued Apr. 3, 2007, which is a continuation of U.S. patent application Ser. No. 09/847,005 filed on May 2, 2001, now U.S. Pat. No. 7,031,716, issued Apr. 18, 2006, which is a continuation of U.S. patent application Ser. No. 09/594,662 filed on Jun. 15, 2000, now U.S. Pat. No. 6,282,406, issued Aug. 28, 2001, which is a continuation of U.S. patent application Ser. No. 09/259,417, filed on Dec. 9, 1997, now U.S. Pat. No. 6,108,520, issued Aug. 22, 2000, which is a continuation of U.S. patent application Ser. No. 08/608,629 filed on Feb. 29, 1996, now U.S. Pat. No. 5,729,827, issued Mar. 17, 1998, which is a divisional of U.S. patent application Ser. No. 08/264,973, filed Jun. 24, 1994, now U.S. Pat. No. 5,542,115, issued Jul. 30, 1996, entitled "PAGING METHOD AND APPARATUS," naming Wong, et al. as inventors, all of these applications being incorporated by reference herein in their entirety.

BACKGROUND

1. Technical Field

This invention pertains to communications paging, and particularly to two-way paging method and apparatus.

2. Related Art

Over the last several decades, pagers have proven to be important communication devices for contacting remotely situated personnel. Whereas primitive pagers provided primarily only a tonal and/or vibratory output, more modern pagers have enhanced output capabilities such as message-bearing alphanumeric displays.

Paging systems have historically been one-way systems. That is, the user receives a paging message from a central terminal but has no way of responding to that message with the pager. Prior art attempts to provide two-way communication capabilities for a pager have included efforts to connect the pager to a telephone (e.g., to a mobile radio telephone). See, for example, U.S. Pat. No. RE 33,417 to Bhagat, et al. (which combines an entire radio pager and radiotelephone linked through an automatic dialer) and U.S. Pat. No. 5,117,449 to Metroka, et. al. (which purports to combine paging and cellular radiotelephone functions in a single unit).

Some pagers have the capability of providing an acknowledgment or response to a paging signal. In some such "ack-back" systems, a user operates a reply input device (e.g., a toggle switch, pushbutton switch, or keyboard) when paged. Typically such ack-back systems involve a complex acknowledgement transmission scheme, involving numerous frequencies or frequency sub-bands. Hand-off of the pager, as the pager travels between differing geographic regions or "cells" served by differing central stations, becomes technically cumbersome when multitudinous frequencies are involved.

SUMMARY

A two-way paging system utilizes four local frequencies for transmissions between pager units and a central control station. A first local frequency carries a local clock; a second

local frequency carries communications packets from the central control station to paging units; a third local frequency carries communication packets from the pager units to the central control station; and a fourth local frequency carries a status or request signal from the paging units to the central control station. Transmissions on the fourth local frequency are in accordance with a time divided slot allocation among pager units accessing the central control station.

For a two-way paging system having a plurality of central control stations servicing a corresponding plurality of cells, a total of eight frequencies are utilized within any one cell. Four of the utilized frequencies are the local frequencies (which may differ from cell to cell), and four of the utilized frequencies are lower power common frequencies or switching frequencies which are used to switch or hand-off a pager unit traveling from one cell to another.

BRIEF DESCRIPTION OF THE DRAWINGS

The foregoing and other objects, features, and advantages of the invention will be apparent from the following more particular description of preferred embodiments as illustrated in the accompanying drawings in which reference characters refer to the same parts throughout the various views. The drawings are not necessarily to scale, emphasis instead being placed upon illustrating the principles of the invention.

FIG. 1 is a schematic view of a central control station included in a paging system of an embodiment of the invention.

FIG. 2 is a schematic view of a pager unit included in a paging system for use with the central control station of FIG. 1.

FIG. 3 is a flowchart depicting steps executed by the central control station of FIG. 1.

FIG. 4 is a flowchart depicting steps executed by the pager unit of FIG. 2 when in a transmit mode.

FIG. 5 is a flowchart depicting steps executed by the pager unit of FIG. 2 when in a receive mode.

FIG. 6 is a timing diagram reflecting communications between the central control station of FIG. 1 and the pager unit of FIG. 2.

FIG. 7 is a schematic view of a central control station included in a paging system of a second embodiment of the invention.

FIG. 8 is a schematic view of a pager unit included in a paging system for use with the central control station of FIG. 7.

FIG. 9 is a hybrid schematic view and timing diagram for representing switching operations for the paging system of the second embodiment of the invention.

FIG. 10 is a flowchart depicting steps executed by the pager unit of FIG. 8 in connection with a channel switching operation.

FIG. 11 is a flowchart depicting steps executed by the central control station of FIG. 7 in connection with a channel switching operation.

FIG. 12 is a schematic view of a format of a communications packet utilized with embodiments of the invention.

FIG. 13 is a schematic view illustrating a time divided slot allocation technique according to the invention.

DETAILED DESCRIPTION

FIG. 1 shows a central control station 20 according to a first embodiment of the invention; FIG. 2 shows a paging unit 22 suitable for use with central control station 20.

As shown in FIG. 1, central control station 20 includes central computer 30; transmitter 32; receiver 34; and computerized telephone answering system 36. Transmitter 32 transmits, via transmitting antenna 42, two local frequencies, namely frequency  $f_1$  and frequency  $f_2$ . Receiver 34 is connected to receiver antenna 44 for reception of two local frequencies, namely frequency  $f_3$  and frequency  $f_4$ . Computerized telephone answering system 36 is connected to a bank of telephones 48.

Central computer 30 of central control station 20 comprises a conventional computer equipped with typical components including a CPU 50; I/O interface 52; and memory 54. Although shown only generally in FIG. 1, it should be understood that memory 54 includes a number of unillustrated memory devices, including (for example) a hard disk drive, RAM, and ROM. FIG. 1 shows that memory 54 has stored therein (among other things) a pager registration file 55 and a pager directory file 56. Pager files 55 and 56 are typically stored on a hard disk drive of central computer 30, and upon start-up are loadable into a RAM portion of memory 54.

Central computer 30 of central control station 20 further includes a decoder 57 (connected between receiver 34 and I/O interface 52 for decoding in-coming communications information from one or more pager units 22), as well as encoder 58 (connected between I/O interface 52 and transmitter 32 for encoding out-going communications information).

Central control station 20 also includes a clock unit 59 which generates a local clock signal  $f_1\text{clk}$  (which, in turn, is used to modulate frequency  $f_1$ ).

As illustrated further herein, CPU 50 of central control station 20 prepares communications packets for transmission on frequency  $f_2$ . As generally illustrated in FIG. 12, the communications packets are of a predetermined format, having fields for identification of the central control station, for identification of the addressed pager unit(s) 22, for an operation code, for (optionally) alphanumeric information, and for other conventional packet-type information such as checksum, error correction, and postamble. The preamble and postamble are specially chosen patterns which can be recognized and distinguished from data for the purpose of determining the beginning and ending of a packet. The alphanumeric information can be in a customary binary 8-bit format. The format of FIG. 12 is illustrative only, as such information as the order of the fields can be varied in other embodiments.

Central control station 20 communicates with a plurality of pager units  $22_1, 22_2, \dots, 22_N$ . Only one such pager unit, generically referenced as pager unit 22, is specifically illustrated and described herein, it being understood that the construction and operation of other pager units may be similar to the one illustrated.

As shown in FIG. 2, pager unit 22 includes a pager receiver antenna 60 which is connected to pager receiver 62. Pager receiver 62 is, in turn, connected through S/D converter 64 within pager computer 70. Receiver 62 receives the two local frequencies  $f_1$  and  $f_2$ , which frequencies have been modulated to carry in-coming communications information (described in more detail below) to pager computer 70. On a communications output side, pager computer 70 outputs out-going communications information to pager transmitter 72 via D/S converter 74. Transmitter 72 broadcasts, on pager antenna 76, the out-going communications information on the two local frequencies  $f_3$  and  $f_4$ .

As also shown in FIG. 2, pager computer 70 includes pager microprocessor 80 which is connected to each of an arithmetic processor; a memory system 84 (including both ROM and RAM); and I/O interface 86. I/O interface 86 is connected to a clock unit 87. I/O interface 86 is also connected to receive

in-coming decoded communications information from an 8-bit decoder 88 and to output out-going uncoded communications information to an 8-bit encoder 90. Decoder 88 is connected to receive in-coming coded communications information from S/D converter 64; encoder 90 is connected to output out-going coded communications information to D/S converter 74.

Clock unit 87 is settable by suitable inputs thereto so that clock unit 87 generates a local clock signal  $f_1\text{clk}$  having a frequency corresponding to its input. It should be understood that, in other embodiments, the function of clock unit 87 can be performed at least partially by microprocessor 80 using programmed execution.

I/O interface 86 is also connected to supply an on/off signal on line 92 to pager transmitter 72, as well as to facilitate input and output with numerous input/output devices. The input/output devices connected to I/O interface 86 include keyboard 93; beeper 94; vibrator 95; and LCD (alphanumeric) display 96.

Upon manufacture, pager unit 22 is preprogrammed with an identification serial number (e.g., a 7-digit alphanumeric pre-assigned ID number) which is stored in memory 84 (ROM). Pager unit 22 is activated (e.g., at the time of purchase) by inserting a time slot assignment (explained below) both into a predetermined address in memory 84 of pager unit 22 and into pager directory file 56 (stored in memory 54 of central control station 20).

#### Operation of First Embodiment

Communication between central control station 20 and pager unit 22 occurs on the four local frequencies, in particular the frequencies  $f_1, f_2, f_3$ , and  $f_4$  mentioned above. The first frequency ( $f_1$ ) carries the local clock-aligning signal from central control station 20 to paging unit 22. The second frequency ( $f_2$ ) carries a pager command and alphanumeric data from central control station 20 to paging unit 22. The third frequency ( $f_3$ ) carries pager status data and alphanumeric data from paging unit 22 to central control station 20. The fourth frequency ( $f_4$ ) carries a pager request signal from paging unit 22 to central control station 20. In the illustrated embodiment, the frequencies  $f_1$ - $f_4$  are preferably chosen so that  $f_1 \neq f_2 \neq f_3 \neq f_4$ .

As explained in more detail below and illustrated in FIG. 13, in normal non-cell-switching operation, the pager request signal on frequency  $f_4$  is transmitted in a predetermined time slot assigned to paging unit 22. The predetermined time slot on frequency  $f_4$  is related to the clock-aligning signal (carried by frequency  $f_1$ ) and assigned whereby the fourth frequency is utilizable by a plurality of other paging units. For example, as shown in FIG. 13, a first time slot on frequency  $f_4$  is assigned to a pager P1; a second time slot is assigned to pager P2, and so on up to time slot n assigned to pager Pn. In the illustrated embodiment, the number of time slots (and accordingly the number of pagers) may be as many as ten thousand or more.

FIG. 3 shows steps executed by CPU 50 of central control station 20 in processing communications to and from one or more paging units. The steps depicted in FIG. 3 are indicative of instructions stored in a ROM portion of memory 54 of central control station 20.

When central control station 20 is started up (step 100), an initialization process (step 102) is conducted. Included in the initialization process is activation of transmitter 32 (so that transmitter 32 can transmit at the two frequencies  $f_1$  and  $f_2$ ) and activation of receiver 34 (so that receiver 34 can receive the two frequencies  $f_3$  and  $f_4$ ). Moreover, frequency  $f_1$  is

modulated to carry the local clock-aligning signal generated by local clock 59. Then, at step 104, the pager registration file 55 and the pager directory file 56 are loaded from hard disk into a RAM section of memory 54 (step 104).

After initialization and loading of the files 55 and 56, CPU 50 repetitively executes an instruction loop 106. Loop 106 involves checking to determine (at step 108) whether a telephone message is being received (via answering system 36 from one of the telephones in bank 48) and checking to determine (at step 110) whether a pager message is being received (via transmitter 32 from one of the pager units 22).

As used herein, a message, whether originated from a telephone or from a pager, may require a plurality of packets for transmission from a central station 20 to a pager 22 or vice versa. In the ensuing discussion, transmission and reception of messages subsumes transmission and reception of one or more packets. In general, the packetization of messages will be invisible to the user, meaning that a user enters a message without regard to the number of packets which might be required to transmit the message. The message typically ends with a user-entered message termination character or message delimiter character. The transmitting device (either central station 20 or pager 22), allocates the message to one or more packets having a format similar to that of FIG. 12, with the last packet in the message bearing the message termination character. Alternatively, the packets may be formatted in a manner to indicate the number of consecutively related packets emanating from a transmitter (e.g., there may be a separate packet field indicating the continuation number of related packets).

Central computer 30 can distinguish between receipt of a telephone message (at step 108) and a pager message (at step 110) by virtue of the fact that I/O interface 52 generates different types of interrupts to CPU 50 depending on the type of message received. If it is determined at step 108 that a telephone message is being received, steps 112, 114, and 116 of FIG. 3 are executed.

In processing a received telephone message, at step 112 central computer 30 extracts out-going communications information from the predeterminedly sequenced telephone-entered data. The telephone-entered data, entered via a touchpad of a calling one of the telephones in bank 48, includes by convention an identification (e.g., telephone number) of the calling telephone; an identification of the called pager unit (e.g., the 7-digit alphanumeric pre-assigned ID number); and any character data for transmission followed by a termination character. This out-going communications information is received at central computer 30 in standard DTMF format.

At step 114, using the ID number of the called pager (obtained at step 112) central computer 30 checks the pager registration file 55 and directory file 56 to determine whether the called pager unit is registered with central control station 20. Assuming that the called pager is so registered, at step 114 the central computer 30 also obtains from pager directory file 56 the slot assignment for the called pager unit.

At step 116, central control station 30 transmits communications information to the called pager unit. In this regard, central control station 20 prepares and transmits (on frequency  $f_2$ ) a communications message which includes, among other things, the ID of the called pager unit and the character data received from the telephone for transmission of the pager unit 22. After step 116 is executed, processing returns to loop 106.

If it is determined at step 110 that a pager message is being received, even numbered steps 132-140 of FIG. 3 are executed (prior to returning to loop 106). As will be seen hereinafter with respect to FIG. 4, a sending pager unit 22

transmits, in its assigned time slot, a request signal on frequency  $f_4$  when the sending pager unit 22 desires to send a message. As central control station 20 is always monitoring frequency  $f_4$ , a request signal carried by frequency  $f_4$  from any pager unit 22 is noted. With reference to the local clock 59, at step 132 CPU 50 determines in what time slot on frequency  $f_4$  the request signal is detected. Upon detection of the time slot at step 132, at step 134 CPU 50 consults the pager directory file 56 to determine the identification number of the particular pager unit 22 which originated the request signal.

With the identity of the requesting pager unit 22 now known, at step 136 central control station 20 authorizes the requesting pager unit 22 to transmit its message. In particular, CPU 50 directs preparation of a communications message for transmission on frequency  $f_2$ . The particular communications packet prepared at step 136 includes an identification of the requesting pager unit (the addressee of the packet), as well as an operation code ("op" code) which commands/authorizes the requesting pager unit 22 to send its message.

At step 138, central control station 20 receives a communications message on frequency  $f_3$  sent from the sending (e.g., requesting) pager unit 22. The communications message prepared and sent by the sending pager unit 22 includes packets of similar format to that shown in FIG. 12, and includes an identification of a pager to which the message is ultimately addressed as well as its own identification. At step 138, CPU 50 checks to ensure that the ultimate addressee pager unit is registered in pager files 55 and 56. At step 140, CPU 50 makes any necessary reformatting and/or information substitution in the message, and causes the message to be transmitted on frequency  $f_2$ . The transmission on frequency  $f_2$  required by step 140 includes the identification of the ultimate addressee (e.g., a pager unit 22) as well as an operation code indicating that the transmission includes a relayed message from another pager unit.

Steps executed by a pager unit 22 in connection with its transmission mode are depicted in FIG. 4. Steps executed by a pager unit 22 in connection with its receive mode are depicted in FIG. 5. The term "mode" as used herein does not connote exclusivity at any particular moment, for it should be remembered that at all times pager unit 22 is receiving transmissions on frequencies  $f_1$  and  $f_2$ .

In its transmission mode (see FIG. 4), after start-up (step 200) microprocessor 80 of the transmitting pager unit 22 executes a loop 202 wherein user alphanumeric characters (entered via keyboard 93) are repetitively fetched (at step 204) until an end of message delimiter is detected (at step 206). As entered, the characters fetched at step 204 are displayed on LCD display 96. Entry of the delimiter character at step 206 causes microprocessor 80 to exit loop 202. By convention, the message must include an addressee ID, which addressee ID is likely the ID of another one of the pager units to which the message entered in step 204 is directed.

After entry of the message awaits entry from keyboard 93 of a transmit command at step 212. Assuming that the transmit command is entered at step 212, microprocessor 80 prepares and sends a request signal on frequency  $f_4$ . As indicated before, the request signal is transmitted on frequency  $f_4$  in a time slot assigned to the requesting pager unit 22. It should be kept in mind that pager unit 22 is all the while receiving the local clock-aligning signal on frequency  $f_1$ , which enables microprocessor 80 to cause transmission of the request signal on frequency  $f_4$  at a time corresponding to the specific time slot allotted to the particular sending pager unit 22.

In the above regard, in accordance with time division techniques, each pager unit  $22_1-22_N$  (e.g., pagers  $P_1-P_N$  in FIG. 13) is assigned a selected one of N number of time slots on frequency  $f_4$ .

After transmission of the request signal at step 214, pager unit 22 awaits receipt of a transmit command from central control station 20. Preparation and transmission of the transmit command/authorization from central control station 20 is described with reference to FIG. 3. Upon receipt of the transmit command/authorization from central control station 20 (step 216), microprocessor 80 prepares (at step 218) a communications message with one or more packets having a format much like that of FIG. 12. The addressee ID and alphanumeric field of packets of the communications message is filled with the message entered in loop 202. At step 220, the sending pager unit 22 broadcasts the communications packet on frequency  $f_3$ .

If a transmit command is not entered at step 212, or after transmission of the message at step 220, microprocessor 80 awaits entry of at least one of several possible special function keys at step 222. For example, the user may press a function key which requires storage of the message (whether yet transmitted or not) [see step 228]. Alternatively, the user may press function keys which facilitate editing or erasure of the message (see steps 224 and 226, respectively). To complete the message and begin work on another message, a special function key for an exit operation (step 230) must be pressed.

FIG. 5 depicts steps executed by microprocessor 80 of pager unit 22 when in a receive mode. After start-up (step 302), and as indicated by step 304, pager unit 22 receives transmissions from central control station 20 on frequency  $f_2$ . Once a complete packet is received (determined at step 306), a check is made (at step 308) whether the addressee ID in the communications packet (see packet format of FIG. 12) is the ID of the receiving pager unit 22. If the determinations of either step 306 or 308 are negative, pager unit 22 awaits either completion of the communications packet (in the case of step 306) or receipt of another communications packet (in the case of step 308) by looping back to step 304.

Assuming that the received communications packet is designated for this particular receiving pager unit 22, at step 310 microprocessor 80 consults the operation code field of the communications packet (see FIG. 12) to determine if the operation code indicates that the message includes a command. If the operation code indicates a command, a command processing routine (framed by broken lines 312 in FIG. 5) is executed.

Assuming for the moment that the operation code does not indicate a command, at step 314 microprocessor 80 of pager unit 22 stores the alphanumeric field portion of the communications packet (which at least partially forms the message) in a RAM portion of memory 84. Since a message communicated from central processing station 20 may require several communications packets for completion of the message (with subsequent communication packets providing continuations of the message content), microprocessor 80 checks at step 316 to ensure that the entire message has been received. If not, processing continues back at step 304 for reception of a further communications packet.

Upon reception of an entire communications message, at step 318 microprocessor 80 determines whether pager unit 22 is in a beep mode or a vibrate mode. In this regard, there are numerous ways of setting paging unit 22 to the desired mode, either by a specially dedicated switch on paging unit 22 or by data entry using keyboard 93. If pager unit 22 is in a beep mode, microprocessor 80 outputs a signal which causes I/O interface 86 to issue a further signal to activate beeper 94 (step

320). Alternatively, if pager unit 22 is in a vibrate mode, microprocessor 80 outputs a signal which causes I/O interface 86 to issue a further signal to activate vibrator 95 (step 322).

At step 324, microprocessor 80 directs I/O interface 86 to send the alphanumeric message data to LCD display 96, so that the received message can be viewed by the user.

After notification to the user (either via beeper 94 and/or vibrator 95), and display (on LCD 96) of the received alphanumeric data, microprocessor 80 returns to step 304 to check whether further communications packets are being received.

The command processing routine (framed by broken lines 312 in FIG. 5) first determines (step 330) which particular operation is being commanded. This determination is based on the content of the operation code, which is different for different command types. If the operation code indicates an error shut-down, execution jumps to an error shut-down sub-routine which begins at step 340. If the operation code indicates a time slot change, execution jumps to a change time slot sub-routine which begins at step 350. If the operation code requires transmitter shut-down, execution jumps to a transmitter shut-down sub-routine which begins at step 360. If the operation code requires transmitter re-enablement, execution jumps to a transmitter reenable sub-routine which begins at step 370. If the operation code requires clock re-set, execution jumps to a clock re-set sub routine which begins at step 380.

In connection with the error shut down sub-routine, at step 342 microprocessor 80 obtains an indication of error type from the communications packet. The error type is stored in memory 84 (step 344) and then displayed on LCD display 96 (step 346). Then microprocessor 80 issues a command (at step 348) to shut down pager unit 22, which shut-down occurs at step 349.

In connection with the time slot changing sub-routine, at step 352 microprocessor 80 extracts, from the received communications packet, information indicative of the new time slot assigned to the receiving pager unit 22. The new time slot is entered (at step 354) into memory 84 and thereafter utilized (until further change) in connection with transmission of request signals on frequency  $f_4$  (see, for example, step 214 of FIG. 4).

The time slot changing sub-routine may also include other operations, if desired, including (for example) eliminating unused time slots (thereby increasing scanning rate); diagnosing and trouble shooting; and avoiding interruption of service from malfunctioning or ill-functioning equipment.

In connection with the transmitter shut down sub-routine, at step 362 microprocessor 80 directs I/O interface 86 to issue an OFF command to transmitter 72. In connection with the transmitter re-enable sub-routine, at step 372 microprocessor 80 directs I/O interface 86 to issue an ON command to transmitter 72.

In connection with the clock re-set sub-routine, at step 382 microprocessor 80 directs that clock 59 of pager unit 22 be set.

After execution of steps 354, 362, 372, or 382, execution continues back to step 304 for processing of potential further communications packets. Thus, unless an error shut-down is noted, each entry of the command processing routine (framed by broken lines 312 in FIG. 5) is followed by a loop back to step 304.

FIG. 6 is a timing diagram showing the frequencies  $f_1-f_4$  and integration of the steps depicted in FIGS. 3-5, particularly in the context of a request by a sending pager unit P1 for sending a message to a sendee pager unit P2. As employed in FIG. 6, "computer" refers to central control station 20. It should be understood that the sending pager unit P1 and the

sendee pager unit P2 operate in both the transmission mode as depicted in FIG. 4 and in the receiver mode as depicted in FIG. 5. In general, FIG. 6 shows transmission of a message from pager unit P1 (via central control station 20) to pager unit P2; transmission of a confirmation message from pager unit P2 (via central control station 20) to pager unit P1; and transmission of a message from pager unit P1 to central control station 20 indicating that pager unit P1 received the confirmation message from pager unit P2.

#### Structure of Second Embodiment

FIG. 7 shows a central control station 420 according to a second embodiment of the invention; FIG. 8 shows a paging unit 422 suitable for use with central control station 420.

FIG. 9 shows a wide area paging system including a plurality of central control stations S1-S8 (each identical to central control station 420), each preferably geographically centered within a respective cell. Each central control station S1-S8 broadcasts its own local frequencies, as well as a set of common or switching frequencies  $C_1$ - $C_4$ . The common frequencies  $C_1$ - $C_4$  are broadcast at a lower power, so that reception thereof occurs only in a relatively small neighborhood or common frequency reception region (CFRR) [also referred to as a "switching region"] about the central control station. The local frequencies are broadcast at a significantly greater power for reception substantially throughout the cell. For example, in FIG. 9, central control station S1 broadcasts its lower power common frequencies  $C_1$ - $C_4$  to CFRR<sub>1</sub> and its higher power local frequencies  $f_1$ - $f_4$  to CELL<sub>1</sub>; central control station S2 broadcasts its lower power common frequencies  $C_1$ - $C_4$  to CFRR<sub>2</sub> and its higher power local frequencies  $f_5$ - $f_8$  to CELL<sub>2</sub>.

As also shown in FIG. 9, CELL<sub>1</sub> and CELL<sub>2</sub> overlap in an overlap region shown in FIG. 9. Station S1 utilizes a set of local frequencies  $f_1$ - $f_4$ ; station S2 utilizes a different set of local frequencies  $f_5$ - $f_8$ . Both stations S1 and S2 utilize the same set of common or switching frequencies  $C_1$ - $C_4$ . Thus, each central control station utilizes two sets of frequencies, there being four frequencies in each set, resulting in a total of eight frequencies handled per station.

Thus, the second embodiment of the invention is suitable for a system having a plurality of central control stations 420<sub>x</sub>, where  $x=1, 2, \dots, M$ . Each central control station 420<sub>x</sub> transmits and receives a set of local frequencies  $f_{L1}, f_{L2}, f_{L3}, f_{L4}$  in an associated geographical area or cell, as well as the set of common or switch frequencies  $C_1, C_2, C_3, C_4$ . While the values of the local frequencies  $f_{L1}, f_{L2}, f_{L3}, f_{L4}$ , vary from cell to cell (e.g., differ for differing central control stations 420<sub>x</sub>), the values of the common or switch frequencies  $C_1, C_2, C_3, C_4$  are uniform through the system (e.g., for all central control stations 420<sub>x</sub>).

Although not shown in FIG. 9, it should be understood that the pattern of central control stations repeats in like manner in all compass directions in accordance with the prescribed geographical boundaries of the paging system. Moreover, although not specifically illustrated in FIG. 9, it should also be understood that each central control station 420 has an associated CFRR.

The common or switching frequencies  $C_1$ - $C_4$  have an analogous function to the corresponding local frequencies  $f_1$ - $f_4$ , respectively. In this regard, frequency  $C_1$  carries a clock frequency transmitted by central control station(s), although the clock rate on common frequency  $C_1$  preferably varies among central control stations. Frequency  $C_2$  is used to transmit information from central control station(s) to pager unit(s); frequency  $C_3$  is used to transmit information from a

pager unit to a central control station; frequency  $C_4$  is used by pager units to issue a request signal. Frequency  $C_2$  carries packets having a format similar to that of FIG. 12. In analogous manner to frequency  $f_2$ , the packets carried by frequency  $C_2$  may have command codes. Among the  $C_2$  command codes are a SYSTEM COMMAND CODE; a LOCAL FREQUENCY DOWNLOAD COMMAND CODE; a SLOT RECOGNITION COMMAND CODE; and a SLOT ASSIGNMENT COMMAND CODE.

As shown in FIG. 7, central control station 420 resembles central control station 20 of the embodiment of FIG. 1 (similar components being assigned the same reference numerals for simplicity). However, central control station 420 is augmented by inclusion of a further transmitter, known as common frequency transmitter 432, together with its common frequency transmission antenna 442, for transmitting the common frequencies  $C_1$  and  $C_2$ . In contrast to the high power transmitter 32, transmitter 432 is a low power transmitter. Further, central control station 420 is augmented by inclusion of a further receiver, known as the common frequency receiver 434, together with its common frequency receiver antenna 444, for reception of the common frequencies  $C_3$  and  $C_4$ .

Central control station 420 of FIG. 7 includes a clock unit 59' which generates two clocking signals—a first or local clocking signal  $f_L$ clk and a second or common clocking signal  $C_1$ clk. The local clocking signal  $f_L$ clk is used to modulate frequency  $f_1$ ; the common clocking signal is used to modulate the common frequency  $C_1$ .

The central computers 30 of the central control stations 420<sub>x</sub> are serially connected to one another by an output line 486A and an input line 486B. In particular, although not expressly shown as such in FIG. 7, computer 30 of FIG. 7 (like that of FIG. 1) includes an I/O interface to which the serial lines 486A and 486B are connected. Serial lines 486A and 486B are used, for example, to update contents of the pager registration file 55 and the pager directory file 56.

As shown in FIG. 8, pager unit 422 resembles pager unit 22 of the embodiment of FIG. 2 (similar components again being assigned the same reference numerals for simplicity). However, pager unit 422 (in like manner as central control station 420) is augmented by inclusion of a further transmitter, known as common frequency transmitter 572, together with its common frequency transmission antenna 576, for transmitting the common frequencies  $C_3$  and  $C_4$ . Further, central control station 420 is augmented by inclusion of a further receiver, known as the common frequency receiver 434, together with its common frequency receiver antenna 444, for reception of the common frequencies  $C_1$  and  $C_2$ .

The operational frequencies of transmitter 72 and receiver 62 are changeable in accordance with values transmitted on "frequency control" lines from computer 70. In particular, the frequency control lines are connected to I/O interface 86 in computer 70. As described in more detail below, when a pager unit 422 migrates into a new CFRR, signals are applied on the frequency control lines in order to switch pager unit 422 from the local frequencies of an old cell to the local frequencies of a new cell associated with the new CFRR into which pager unit 422 migrates.

Pager 422 includes a clock unit 83' which is capable of separately generating local clocking signals  $f_L$ clk and the common clocking signals  $f_{C1}$ clk for use by microprocessor 80. These clocking signals are initiated and their frequencies set by appropriate respective inputs to clock unit 83'.

FIG. 8 also shows that pager unit 422 has data I/O unit 596 which includes both an alphanumeric graphic display and a pressure sensitive writing pad. The alphanumeric graphic



display is a dot matrix device which can display characters and graphics. The writing pad has a 16x48 dot area.

#### Operation of Second Embodiment

As shown in FIG. 9, a pager unit P1 is assumed to have been operating in CELL<sub>1</sub> and to have previously received the common frequencies C<sub>1</sub>-C<sub>4</sub> and local frequencies f<sub>1</sub>-f<sub>2</sub> from station S1. Now pager unit P1 travels on a route indicated by broken arrow-headed line ROUTE. In traveling along the ROUTE, pager unit P1 continues to operate on local frequencies f<sub>1</sub>-f<sub>2</sub>, even as it travels through the cellular overlap region. However, when pager unit P1 enters a new common frequency reception region (i.e., CFRR<sub>2</sub>), a switching or hand-off operation occurs. In the switching operation, as explained in more detail below, pager unit P1 obtains common frequencies C<sub>1</sub>-C<sub>4</sub> from central control station S2 and, as a result, can switch from the local frequencies f<sub>1</sub>-f<sub>4</sub> of CELL<sub>1</sub> to the local frequencies f<sub>5</sub>-f<sub>8</sub> of CELL<sub>2</sub>. In order to effect the switching or hand-off operation, pager unit P1 executes a channel switching routine; the central control station S2 executes a switching enabling routine.

In connection with the channel switching routine and the switching enabling routine, when pager unit P1 moves into CFRR<sub>2</sub>, pager unit P1 will receive the clocking signal on frequency C<sub>1</sub> from station S2. At such point, pager unit P1 will automatically align its clock unit with the clocking signal from station S2.

Referring now to the channel switching routine executed by pager P1 subsequent to start-up (step 500), at step 506 pager unit P1 obtains information characterizing the system centered about station S2. Such characterizing information is referred to as system identification or system ID information.

At step 508, microprocessor 80 of pager unit P1 checks to determine if there is any new system ID information acquired on frequency C<sub>2</sub>. That is, microprocessor 80 checks to determine if system ID information is received on frequency C<sub>2</sub> (which can occur only in a CFRR) and, if so, compares the system ID information to the immediately previously-stored system ID information. If the previous and most recently-acquired system IDs are the same, pager unit P1 realizes that it is still in the jurisdiction of the same station (e.g., station S1). If not, pager unit P1 realizes that it has now wandered into a CFRR of a new station (e.g., station S2) and, at step 510, initiates a request on frequency C<sub>4</sub> for communication with the central control station (e.g., station S2) for CELL<sub>2</sub>.

In the above regard, since pager unit P1 has not yet been assigned a time slot for CELL<sub>2</sub>, the request on frequency C<sub>4</sub> is randomly made. However, pager unit P1 keeps track of the time slot in which it makes its request to the new central control station (e.g., station S2).

Thereafter, pager unit P1 continues to monitor (step 512) communications packets from station S2 on frequency C<sub>2</sub>, waiting for station S2 to issue a message which references the time slot at which pager unit P1 made its request of step 510. In particular, pager unit P1 awaits a message from station S2 on frequency C<sub>2</sub> that includes both a SLOT RECOGNITION COMMAND CODE and information stored in the same time slot which pager unit P1 randomly generated. Since the message including the SLOT RECOGNITION COMMAND CODE includes station S2 as the sender and mirrors the slot randomly generated by pager unit P1, pager unit P1 recognizes the message as being addressed to pager unit P1 and considers issuance of such a message by station S2 (see step 612 of FIG. 11) to constitute authority for pager unit P1 to communicate further with station S2. In this regard, at step 514 microprocessor 80 of pager unit P1 determines if there is

a match between the time slot of a received message and the time slot at which the random request was made at step 510.

Assuming a match is eventually found at step 514, at step 516 pager unit P1 sends a communications packet on frequency C<sub>3</sub> to station S2, with the communications packet including the identification or ID of pager unit P1. Using pager registration file 55, station S2 verifies that the ID of pager unit P1 is a valid ID, and thereafter sends (on frequency C<sub>2</sub>) to pager unit P1 a message with the command code LOCAL FREQUENCY DOWNLOAD, which message informs pager unit P1 of the values of the local frequencies handled by station S2 (e.g., frequencies f<sub>5</sub>-f<sub>8</sub>). Thereafter, as also reflected by step 518, station S2 sends (on frequency C<sub>2</sub>) to pager unit P1 a message with the command code SLOT ASSIGNMENT COMMAND CODE, which message informs pager unit P1 of its slot assignment on frequency f<sub>8</sub>. Microprocessor 80 then changes its slot allocation by steps which are similar to those discussed with the afore-mentioned change time slot routine (see steps 350, 352, and 354 of FIG. 5). Step 518 of FIG. 10 reflects reception of the local frequency values and reception of the slot assignment.

After acquisition of all local frequencies and the slot assignment is completed (step 520), microprocessor 80 implements (at step 522) a switch to the new local frequencies (e.g., frequencies f<sub>5</sub>-f<sub>8</sub>). In this regard, microprocessor 80 instructs I/O interface 86 to change transmitter 72 from frequencies f<sub>3</sub>, f<sub>4</sub> to frequencies f<sub>7</sub>, f<sub>8</sub>; and to change receiver 62 from frequencies f<sub>1</sub>, f<sub>2</sub> to frequencies f<sub>5</sub>, f<sub>6</sub>. I/O interface 86 accomplishes the frequency changes by applying appropriate values on the frequency control lines connecting the I/O interface to transmitter 72 and receiver 62, respectively.

After the switch to new local frequencies at step 522, microprocessor 80 loops back to step 506, ultimately to determine when any further switching may be required.

Steps involved in the switching enabling routine executed by a central control station (e.g., station S2) are depicted in FIG. 11. After start-up (step 600), CPU 50 executes a loop 602 which enables CPU 50 to clean up its pager directory file 56 and to check if any new pager units have wandered into the cell which it administers.

In particular, at step 604 CPU determines whether its central control station (e.g., S2) has been advised by any other central control station (e.g., S3) that a pager unit, formerly under the control of its central control station (e.g., S2), has come under the control of the other central control station (e.g., S3). Such advisement occurs on the serial links connecting the central control stations 420, and particularly input serial link 486B. If such advisement occurs, the ID for the wandered-away pager is deleted from the pager directory file 56 for station S2 (as reflected by steps 606 and 608).

At step 610, CPU 50 causes messages with a SYSTEM COMMAND CODE to be transmitted on frequency C<sub>2</sub>. As indicated before, messages transmitted on frequency C<sub>2</sub> include a packet(s) having a format such as that shown in FIG. 12. The message with the SYSTEM COMMAND CODE particularly includes the central station ID number in its alphanumeric data field.

At step 612, central control station 420 checks to determine if a request signal has been transmitted by any pager unit 422 on frequency C<sub>4</sub> (as occurred, for example, in context of the discussion of FIG. 10, particularly step 510). Such a request signal would likely be issued from a pager unit 422 which has just wandered into the CFRR controlled by the central control station (e.g., into CFRR<sub>2</sub> controlled by station S2). If no such request signal is detected, loop 602 is again repeated.

In the event that a request signal is detected at step 612, central control station 420 notes specifically the time slot on

frequency  $C_4$  at which the request occurred (step 614). At this point, such time slot is the only way central control station 420 can identify the in-wandering pager unit 422. Central control station 420 desires for the in-wandering pager unit 422 to transmit its identification (ID), but cannot specifically address the in-wandering pager other than with reference to the detected time slot. Accordingly, at step 616, central control station 420 prepares and transmits a message on frequency  $C_2$  which has a SLOT RECOGNITION COMMAND CODE. The message including the SLOT RECOGNITION COMMAND CODE includes station S2 as the sender and mirrors the slot randomly generated by pager unit P1 (e.g., the time slot at which the in-wandering pager unit 422 issued its request). This transmission on frequency  $C_2$  constitutes authority for pager unit P1 to transmit its identification.

Step 618 denotes acquisition by central control station 420 of the identification (ID) of the in-wandering pager unit 422. At step 620, central control station 420 checks its pager registration file 55 to determine if the pager ID is a valid ID. If not, an error message is generated and transmitted (at step 622), followed by a command for pager unit P1 to shut down (see step 624).

Assuming that the identification of pager unit 422 was validated at step 620, CPU 50 checks (at step 630) its pager directory file 56 to locate an available time slot for the in-wandering pager unit 422, and then associates the available time slot with the ID of the in-wandering pager unit 422. Then, at step 632, using a message on frequency  $C_2$  with a LOCAL FREQUENCY DOWNLOAD COMMAND CODE, central control station 420 sends the values of its local frequencies (e.g.,  $f_5, f_6, f_7, f_8$ ) to the in-wandering pager unit 422. The central control station then (at step 634) assigns to the in-wandering pager unit 422 a new time slot on its local frequencies using a message on frequency  $C_2$  with a SLOT ASSIGNMENT COMMAND CODE. Processing of the change time slot command by the in-wandering pager unit 422 is understood with analogous reference to FIG. 5, particularly steps 350, 352, and 354.

Upon completion of step 634, the in-wandering pager unit 422 is fully initiated into its new cell (e.g., CELL<sub>2</sub>), and has left the jurisdiction of its former control station (e.g., CELL<sub>1</sub> and station S1). Accordingly, at step 636, CPU 50 requests its I/O interface to issue a command on serial line 486A which advises (using pager ID) that the in-wandering pager 422 is now under its jurisdiction, so that former jurisdictions (e.g., S1) can delete this pager unit from their pager directory files 56. Such deletion is understood with reference to steps 604-608 as above-described.

In addition to illustrating geographical location of pager P1, stations S1 and S2, and cells CELL<sub>1</sub> and CELL<sub>2</sub>, FIG. 9 shows the relative timing of communications occurring on common frequencies  $C_1$ - $C_4$ . FIG. 9 specifically relates the timing of communications transmissions to specific ones of the aforescribed steps executed by central control station 420 (the switching enabling routine of FIG. 11) and by pager unit 422 (the channel switching routine of FIG. 10).

Although the central control stations 420<sub>x</sub> use the same common frequencies  $C_1$ - $C_4$ , there is no interference or confusion of these signals transmitted from the control stations 420<sub>x</sub>. The common frequencies  $C_1$ - $C_4$  are broadcast at a relatively lower power than the local frequencies  $f_1$ - $f_4$  so that reception of the common frequencies  $C_1$ - $C_4$  occurs only in a limited neighborhood (CFRR) about the central control station 420<sub>x</sub>. Accordingly, pager units 422 traveling through the system receive common frequencies  $C_1$ - $C_4$  only in the limited and non-overlapping CFRRs.

System operational characteristics, such as cell diameter, CFRR diameter, power level of the local frequencies (e.g.,  $f_1$ - $f_4$ ), and power level of the common frequencies ( $C_1$ - $C_4$ ) can be field adjusted to suit numerous factors, including particularly the terrain and topography of the geographical region covered by the system. By way of non-limiting example, in one embodiment, the radius of each cell is on the order of about 20 miles; while the radius of each CFRR is on the order of about 10 miles or less. In the same example, the power for transmission of the local frequencies can be in a range of from about 3 watts to 1000 watts; while the power for transmission of the common frequencies  $C_1$ - $C_4$  is preferably less than 2 watts.

Thus, the invention provides a two-way paging system which operates independently from a telephone system for wireless data communication between users. The invention minimizes use of available frequencies allowed by the Federal Communications Commission (FCC), using only four local frequencies  $f_1$ - $f_4$  for any given cell and (for expanded, multi-cellular coverage) only four common or switching frequencies  $C_1$ - $C_4$ . In order to minimize the number of frequencies (e.g., channels) utilized, techniques of time division sharing and synchronization are employed. A transmission power differential between the local frequencies and the common frequencies is also employed. These techniques allow data transmission to be kept separate from different pagers and thus eliminate merging of data.

The switching technique of the present invention provides extended geographical coverage and minimizes paging time by increasing the number of frequencies utilized in a cell from four (e.g., the four local frequencies) to eight (the four local frequencies plus the four common frequencies).

In connection with verification of pager ID, it should be understood that a single pager registration file might be stored in a memory file of only one of a plurality of central control stations, and that in such case verification would constitute issuing a search command (on the serial links 486) to locate a pager ID in the one (remote) memory file, with the results of the search being reported back to the inquiring central control station.

The keyboards illustrated herein can, in some embodiments, be multi-language keyboards or writing pads which permit typing of English, Chinese, or Japanese languages, for example. The writing pad is especially useful in countries such as Japan, Thailand, the Middle East or China where English-like alphabets are not used. The writing pad could also be used to sketch and transmit graphics. Moreover, data compression/de-compression techniques can be utilized in connection with data transfer.

While the invention has been particularly shown and described with reference to the preferred embodiments thereof, it will be understood by those skilled in the art that various alterations in form and detail may be made therein without departing from the spirit and scope of the invention. For example, it should be understood that repeaters may be employed within cells to facilitate transmission when a pager unit ventures far from a central control station.

What is claimed:

1. A node comprising:
  - at least one processor;
  - a memory; and
  - at least one interface configured to:
    - transmit first upstream signaling information from the node, said first upstream signaling information comprising a reserve request which is transmitted within a first slot allocated to the node;

15

receive first downstream signaling information, said first downstream signaling information being received subsequent to transmission of the reserve request, said first downstream signaling information comprising an allocation of resources to the node for transmitting a packetized message;

transmit the packetized message subsequent to receiving the first downstream signaling information;

receive second downstream signaling information comprising information describing a new cell and determining that the node is authorized to perform a hand-off procedure, said handoff procedure comprising the following steps:

transmit second upstream signaling information, said second upstream signaling information comprising a random access request in a second slot;

receive third downstream signaling information, said third downstream signaling information being received subsequent to transmission of the second upstream signaling information, said third downstream signaling information acknowledging receipt of said second upstream signaling information, said third downstream signaling information comprising information referencing a second slot number wherein the node transmitted said random access request in order for the node to identify that the node is an intended recipient of the third downstream signaling information;

transmit third upstream signaling information from the node, said third upstream signaling information being transmitted subsequent to receiving said third downstream signaling information, said third upstream signaling information from the node comprising identifier information for the node; and

receive fourth downstream signaling information, said fourth downstream signaling information being received subsequent to transmission of the third upstream signaling information, said fourth downstream signaling information comprising an allocation of a third slot to the node for transmitting a subsequent reserve request;

wherein the availability of the third slot by the node recurs until use of the third slot by the node is disabled.

2. The node of claim 1, wherein the first upstream signaling information is transmitted on a first frequency;

wherein the third downstream signaling information is received on a second frequency which differs from the first frequency; and

wherein the second upstream signaling information is transmitted on a third frequency which differs from the first frequency and the second frequency.

3. The node of claim 1, wherein the first upstream signaling information is transmitted on a first frequency;

wherein the first downstream signaling information is received on a second frequency which differs from the first frequency; and

wherein the third downstream signaling information is received on a third frequency which differs from the first frequency and the second frequency.

4. The node of claim 1, wherein the first upstream signaling information is transmitted on a first frequency;

16

wherein the first downstream signaling information is received on a second frequency which differs from the first frequency; and

wherein the packetized message is transmitted on a third frequency which differs from the first frequency and the second frequency.

5. The node of claim 4, wherein the node receives aligning signaling information on a fourth frequency which differs from the first frequency, the second frequency and the third frequency.

6. The node of claim 1, wherein the first upstream signaling information is transmitted on a first frequency;

wherein the first downstream signaling information is received on a second frequency which differs from the first frequency;

wherein the second upstream signaling information is transmitted on a third frequency which differs from the first frequency and the second frequency; and

wherein the third downstream signaling information is received on a fourth frequency which differs from the first frequency, the second frequency and the third frequency.

7. The node of claim 1, wherein the first upstream signaling information is transmitted on a first frequency;

wherein the first downstream signaling information is received on a second frequency which differs from the first frequency;

wherein the packetized message is transmitted on a third frequency which differs from the first frequency and the second frequency;

wherein the second upstream signaling information is transmitted on a fourth frequency which differs from the first frequency, the second frequency and the third frequency; and

wherein the third downstream signaling information is received on a fifth frequency which differs from the first frequency, the second frequency, the third frequency and the fourth frequency.

8. The node of claim 1, wherein the first upstream signaling information is transmitted on a first frequency;

wherein the first downstream signaling information is received on a second frequency which differs from the first frequency;

wherein the packetized message is transmitted on a third frequency which differs from the first frequency and the second frequency;

wherein the second upstream signaling information is transmitted on a fourth frequency which differs from the first frequency, the second frequency and the third frequency;

wherein the third downstream signaling information is received on a fifth frequency which differs from the first frequency, the second frequency, the third frequency, the fourth frequency; and

wherein the third upstream signaling information is transmitted on a sixth frequency which differs from the first frequency, the second frequency, the third frequency, the fourth frequency and the fifth frequency.

9. The node of claim 1, wherein the packetized message comprises data packets; wherein the data packets may include information related to a sequence number, and

17

wherein a final data packet from the packetized message may further comprise information related to terminal indication information indicating that the final data packet is a last data packet.

10. The node of claim 1, wherein the node further comprises a touch sensitive display input device.

11. The node of claim 1, wherein the availability of said first slot allocated to the node recurs until use of the first slot by the node is disabled.

12. A node comprising:

at least one processor;

a memory; and

at least one interface configured to:

transmit first upstream signaling information from the node, said first upstream signaling information comprising a reserve request which is transmitted within a first slot allocated to the node;

receive first downstream signaling information, said first downstream signaling information being received subsequent to transmission of the reserve request, said first downstream signaling information comprising an allocation of resources to the node for transmitting a packetized message;

transmit the packetized message subsequent to receiving the first downstream signaling information;

receive second downstream signaling information comprising information describing a new cell;

transmit second upstream signaling information, said second upstream signaling information comprising a random access request in a second slot;

receive third downstream signaling information, said third downstream signaling information being received subsequent to transmission of the second upstream signaling information, said third downstream signaling information acknowledging receipt of said second upstream signaling information, said third downstream signaling information comprising information referencing a second slot number wherein the node transmitted said random access request in order for the node to identify that the node is an intended recipient of the third downstream signaling information;

transmit third upstream signaling information from the node, said third upstream signaling information being transmitted subsequent to receiving said third downstream signaling information, said third upstream signaling information from the node comprising identifier information for the node;

receive fourth downstream signaling information and determining that the node is authorized to perform a handoff procedure; and

receive fifth downstream signaling information, said fifth downstream signaling information being received subsequent to transmission of the third upstream signaling information, said fifth downstream signaling information comprising an allocation of a third slot to the node for transmitting a subsequent reserve request;

wherein the availability of the third slot by the node recurs until use of the third slot by the node is disabled.

13. The node of claim 12,

wherein the first upstream signaling information is transmitted on a first frequency;

wherein the third downstream signaling information is received on a second frequency which differs from the first frequency; and

18

wherein the second upstream signaling information is transmitted on a third frequency which differs from the first frequency and the second frequency.

14. The node of claim 12,

wherein the first upstream signaling information is transmitted on a first frequency;

wherein the first downstream signaling information is received on a second frequency which differs from the first frequency; and

wherein the third downstream signaling information is received on a third frequency which differs from the first frequency and the second frequency.

15. The node of claim 12,

wherein the first upstream signaling information is transmitted on a first frequency;

wherein the first downstream signaling information is received on a second frequency which differs from the first frequency; and

wherein the packetized message is transmitted on a third frequency which differs from the first frequency and the second frequency.

16. The node of claim 15, wherein the node receives aligning signaling information on a fourth frequency which differs from the first frequency, the second frequency and the third frequency.

17. The node of claim 12,

wherein the first upstream signaling information is transmitted on a first frequency;

wherein the first downstream signaling information is received on a second frequency which differs from the first frequency;

wherein the second upstream signaling information is transmitted on a third frequency which differs from the first frequency and the second frequency; and

wherein the third downstream signaling information is received on a fourth frequency which differs from the first frequency, the second frequency and the third frequency.

18. The node of claim 12,

wherein the first upstream signaling information is transmitted on a first frequency;

wherein the first downstream signaling information is received on a second frequency which differs from the first frequency;

wherein the packetized message is transmitted on a third frequency which differs from the first frequency and the second frequency;

wherein the second upstream signaling information is transmitted on a fourth frequency which differs from the first frequency, the second frequency and the third frequency; and

wherein the third downstream signaling information is received on a fifth frequency which differs from the first frequency, the second frequency, the third frequency; and the fourth frequency.

19. The node of claim 12,

wherein the first upstream signaling information is transmitted on a first frequency;

wherein the first downstream signaling information is received on a second frequency which differs from the first frequency;

wherein the packetized message is transmitted on a third frequency which differs from the first frequency and the second frequency;

19

wherein the second upstream signaling information is transmitted on a fourth frequency which differs from the first frequency, the second frequency and the third frequency;

wherein the third downstream signaling information is received on a fifth frequency which differs from the first frequency, the second frequency, the third frequency; and the fourth frequency; and

wherein the third upstream signaling information is transmitted on a sixth frequency which differs from the first frequency, the second frequency, the third frequency, the fourth frequency and the fifth frequency.

**20.** The node of claim 12,

wherein the packetized message comprises data packets; wherein the data packets may include information related to a sequence number, and

wherein a final data packet from the packetized message may further comprise information related to terminal indication information indicating that the final data packet is a last data packet.

**21.** The node of claim 12, wherein the node further comprises a touch sensitive display input device.

**22.** The node of claim 12, wherein the availability of said first slot allocated to the node recurs until use of the first slot by the node is disabled.

**23.** A node comprising:

at least one processor;

a memory; and

at least one interface configured to:

transmit first upstream signaling information from the node, said first upstream signaling information comprising a reserve request which is transmitted within a first slot allocated to the node;

receive first downstream signaling information, said first downstream signaling information being received subsequent to transmission of the reserve request, said first downstream signaling information comprising an allocation of resources to the node for transmitting a packetized message;

transmit the packetized message subsequent to receiving the first downstream signaling information;

receive second downstream signaling information comprising information describing a new cell;

transmit second upstream signaling information, said second upstream signaling information comprising a random access request in a second slot;

receive third downstream signaling information, said third downstream signaling information being received subsequent to transmission of the second upstream signaling information, said third downstream signaling information acknowledging receipt of said second upstream signaling information, said third downstream signaling information comprising information referencing a second slot number wherein the node transmitted said random access request in order for the node to identify that the node is an intended recipient of the third downstream signaling information;

transmit third upstream signaling information from the node, said third upstream signaling information being transmitted subsequent to receiving said third downstream signaling information, said third upstream signaling information from the node comprising identifier information for the node;

receive fourth downstream signaling information and determining that the node must perform a handoff procedure; and

20

receive fifth downstream signaling information, said fifth downstream signaling information being received subsequent to transmission of the third upstream signaling information, said fifth downstream signaling information comprising an allocation of a third slot to the node for transmitting a subsequent reserve request;

wherein the availability of the third slot by the node recurs until use of the third slot by the node is disabled.

**24.** The node of claim 23,

wherein the first upstream signaling information is transmitted on a first frequency;

wherein the third downstream signaling information is received on a second frequency which differs from the first frequency; and

wherein the second upstream signaling information is transmitted on a third frequency which differs from the first frequency and the second frequency.

**25.** The node of claim 23,

wherein the first upstream signaling information is transmitted on a first frequency;

wherein the first downstream signaling information is received on a second frequency which differs from the first frequency; and

wherein the third downstream signaling information is received on a third frequency which differs from the first frequency and the second frequency.

**26.** The node of claim 23,

wherein the first upstream signaling information is transmitted on a first frequency;

wherein the first downstream signaling information is received on a second frequency which differs from the first frequency; and

wherein the packetized message is transmitted on a third frequency which differs from the first frequency and the second frequency.

**27.** The node of claim 26, wherein the node receives aligning signaling information on a fourth frequency which differs from the first frequency, the second frequency and the third frequency.

**28.** The node of claim 23,

wherein the first upstream signaling information is transmitted on a first frequency;

wherein the first downstream signaling information is received on a second frequency which differs from the first frequency;

wherein the second upstream signaling information is transmitted on a third frequency which differs from the first frequency and the second frequency; and

wherein the third downstream signaling information is received on a fourth frequency which differs from the first frequency, the second frequency and the third frequency.

**29.** The node of claim 23,

wherein the first upstream signaling information is transmitted on a first frequency;

wherein the first downstream signaling information is received on a second frequency which differs from the first frequency;

wherein the packetized message is transmitted on a third frequency which differs from the first frequency and the second frequency;

wherein the second upstream signaling information is transmitted on a fourth frequency which differs from the first frequency, the second frequency and the third frequency; and

21

wherein the third downstream signaling information is received on a fifth frequency which differs from the first frequency, the second frequency, the third frequency; and the fourth frequency.

**30.** The node of claim **23**,

wherein the first upstream signaling information is transmitted on a first frequency;

wherein the first downstream signaling information is received on a second frequency which differs from the first frequency;

wherein the packetized message is transmitted on a third frequency which differs from the first frequency and the second frequency;

wherein the second upstream signaling information is transmitted on a fourth frequency which differs from the first frequency, the second frequency and the third frequency;

wherein the third downstream signaling information is received on a fifth frequency which differs from the first frequency, the second frequency, the third frequency; and the fourth frequency; and

wherein the third upstream signaling information is transmitted on a sixth frequency which differs from the first frequency, the second frequency, the third frequency, the fourth frequency and the fifth frequency.

**31.** The node of claim **23**,

wherein the packetized message comprises data packets; wherein the data packets may include information related to a sequence number, and

wherein a final data packet from the packetized message may further comprise information related to terminal indication information indicating that the final data packet is a last data packet.

**32.** The node of claim **23**, wherein the node further comprises a touch sensitive display input device.

**33.** The node of claim **23**, wherein the availability of said first slot allocated to the node recurs until use of the first slot by the node is disabled.

**34.** A first node comprising:

at least one processor;

a memory; and

at least one interface configured to:

transmit first upstream signaling information from the first node, said first upstream signaling information comprising a reserve request which is transmitted within a first slot allocated to the first node;

receive first downstream signaling information, said first downstream signaling information being received subsequent to transmission of the reserve request, said first downstream signaling information comprising an allocation of resources to the first node for transmitting a packetized message;

transmit the packetized message subsequent to receiving the first downstream signaling information;

receive second downstream signaling information comprising information describing a new cell and determining that the first node is authorized to perform a handoff procedure, said handoff procedure comprising the following steps:

transmit second upstream signaling information, said second upstream signaling information comprising a random access request in a second slot;

receive third downstream signaling information, said third downstream signaling information being received subsequent to transmission of the second upstream signaling information, said third downstream signaling information acknowledging receipt

22

of said second upstream signaling information, said third downstream signaling information comprising information referencing a second slot number wherein the first node transmitted said random access request in order for the first node to identify that the first node is an intended recipient of the third downstream signaling information;

transmit third upstream signaling information from the first node, said third upstream signaling information being transmitted subsequent to receiving said third downstream signaling information, said third upstream signaling information from the first node comprising identifier information for the first node; and

receive fourth downstream signaling information, said fourth downstream signaling information being received subsequent to transmission of the third upstream signaling information, said fourth downstream signaling information comprising an allocation of a third slot to the first node for transmitting a subsequent reserve request;

wherein the availability of said third slot allocated to the first node recurs until use of the third slot by the first node is disabled, and

wherein a additional reserve request transmitted by a second node into a fourth slot allocated to the second node can be transmitted during transmission of the packetized message by the first node.

**35.** The first node of claim **34**,

wherein said additional reserve request transmitted by the second node is transmitted on a differing frequency than said packetized message transmitted by the first node.

**36.** The first node of claim **34**,

wherein the first upstream signaling information is transmitted on a first frequency;

wherein the third downstream signaling information is received on a second frequency which differs from the first frequency; and

wherein the second upstream signaling information is transmitted on a third frequency which differs from the first frequency and the second frequency.

**37.** The first node of claim **34**,

wherein the first upstream signaling information is transmitted on a first frequency;

wherein the first downstream signaling information is received on a second frequency which differs from the first frequency; and

wherein the third downstream signaling information is received on a third frequency which differs from the first frequency and the second frequency.

**38.** The first node of claim **34**,

wherein the first upstream signaling information is transmitted on a first frequency;

wherein the first downstream signaling information is received on a second frequency which differs from the first frequency; and

wherein the packetized message is transmitted on a third frequency which differs from the first frequency and the second frequency.

**39.** The first node of claim **38**, wherein the first node receives aligning signaling information on a fourth frequency which differs from the first frequency, the second frequency and the third frequency.

**40.** The first node of claim **34**,

wherein the first upstream signaling information is transmitted on a first frequency;

23

wherein the first downstream signaling information is received on a second frequency which differs from the first frequency;  
 wherein the second upstream signaling information is transmitted on a third frequency which differs from the first frequency and the second frequency; and  
 wherein the third downstream signaling information is received on a fourth frequency which differs from the first frequency, the second frequency and the third frequency.

41. The first node of claim 34,  
 wherein the first upstream signaling information is transmitted on a first frequency;  
 wherein the first downstream signaling information is received on a second frequency which differs from the first frequency;  
 wherein the packetized message is transmitted on a third frequency which differs from the first frequency and the second frequency;  
 wherein the second upstream signaling information is transmitted on a fourth frequency which differs from the first frequency, the second frequency and the third frequency; and  
 wherein the third downstream signaling information is received on a fifth frequency which differs from the first frequency, the second frequency, the third frequency; and the fourth frequency.

42. The first node of claim 34,  
 wherein the first upstream signaling information is transmitted on a first frequency;  
 wherein the first downstream signaling information is received on a second frequency which differs from the first frequency;  
 wherein the packetized message is transmitted on a third frequency which differs from the first frequency and the second frequency;  
 wherein the second upstream signaling information is transmitted on a fourth frequency which differs from the first frequency, the second frequency and the third frequency;  
 wherein the third downstream signaling information is received on a fifth frequency which differs from the first frequency, the second frequency, the third frequency; and the fourth frequency; and  
 wherein the third upstream signaling information is transmitted on a sixth frequency which differs from the first frequency, the second frequency, the third frequency, the fourth frequency and the fifth frequency.

43. The first node of claim 34,  
 wherein the packetized message comprises data packets;  
 wherein the data packets may include information related to a sequence number, and  
 wherein a final data packet from the packetized message may further comprise information related to terminal indication information indicating that the final data packet is a last data packet.

44. The first node of claim 34, wherein the first node further comprises a touch sensitive display input device.

45. The first node of claim 34, wherein the availability of said first slot allocated to the first node recurs until use of the first slot by the first node is disabled.

46. A first node comprising:  
 at least one processor;  
 a memory; and  
 at least one interface configured to:  
 transmit first upstream signaling information from the first node, said first upstream signaling information

24

comprising a reserve request which is transmitted within a first slot allocated to the first node;  
 receive first downstream signaling information, said first downstream signaling information being received subsequent to transmission of the reserve request, said first downstream signaling information comprising an allocation of resources to the first node for transmitting a packetized message;  
 transmit the packetized message subsequent to receiving the first downstream signaling information;  
 receive second downstream signaling information comprising information describing a new cell;  
 transmit second upstream signaling information, said second upstream signaling information comprising a random access request in a second slot;  
 receive third downstream signaling information, said third downstream signaling information being received subsequent to transmission of the second upstream signaling information, said third downstream signaling information acknowledging receipt of said second upstream signaling information, said third downstream signaling information comprising information referencing a second slot number wherein the first node transmitted said random access request in order for the first node to identify that the first node is an intended recipient of the third downstream signaling information;  
 transmit third upstream signaling information from the first node, said third upstream signaling information being transmitted subsequent to receiving said third downstream signaling information, said third upstream signaling information from the first node comprising identifier information for the first node;  
 receive fourth downstream signaling information and determining that the first node is authorized to perform a handoff procedure; and  
 receive fifth downstream signaling information, said fifth downstream signaling information being received subsequent to transmission of the third upstream signaling information, said fifth downstream signaling information comprising an allocation of a third slot to the first node for transmitting a subsequent reserve request;  
 wherein the availability of said third slot allocated to the first node recurs until use of the third slot by the first node is disabled, and  
 wherein a additional reserve request transmitted by a second node into a fourth slot allocated to the second node can be transmitted during transmission of the packetized message by the first node.

47. The first node of claim 46,  
 wherein said additional reserve request transmitted by the second node is transmitted on a differing frequency than said packetized message transmitted by the first node.

48. The first node of claim 46,  
 wherein the first upstream signaling information is transmitted on a first frequency;  
 wherein the third downstream signaling information is received on a second frequency which differs from the first frequency; and  
 wherein the second upstream signaling information is transmitted on a third frequency which differs from the first frequency and the second frequency.

49. The first node of claim 46,  
 wherein the first upstream signaling information is transmitted on a first frequency;

25

wherein the first downstream signaling information is received on a second frequency which differs from the first frequency; and

wherein the third downstream signaling information is received on a third frequency which differs from the first frequency and the second frequency.

**50.** The first node of claim **46**,

wherein the first upstream signaling information is transmitted on a first frequency;

wherein the first downstream signaling information is received on a second frequency which differs from the first frequency; and

wherein the packetized message is transmitted on a third frequency which differs from the first frequency and the second frequency.

**51.** The first node of claim **50**, wherein the first node receives aligning signaling information on a fourth frequency which differs from the first frequency, the second frequency and the third frequency.

**52.** The first node of claim **46**,

wherein the first upstream signaling information is transmitted on a first frequency;

wherein the first downstream signaling information is received on a second frequency which differs from the first frequency;

wherein the second upstream signaling information is transmitted on a third frequency which differs from the first frequency and the second frequency; and

wherein the third downstream signaling information is received on a fourth frequency which differs from the first frequency, the second frequency and the third frequency.

**53.** The first node of claim **46**,

wherein the first upstream signaling information is transmitted on a first frequency;

wherein the first downstream signaling information is received on a second frequency which differs from the first frequency;

wherein the packetized message is transmitted on a third frequency which differs from the first frequency and the second frequency;

wherein the second upstream signaling information is transmitted on a fourth frequency which differs from the first frequency, the second frequency and the third frequency; and

wherein the third downstream signaling information is received on a fifth frequency which differs from the first frequency, the second frequency, the third frequency; and the fourth frequency.

**54.** The first node of claim **46**,

wherein the first upstream signaling information is transmitted on a first frequency;

wherein the first downstream signaling information is received on a second frequency which differs from the first frequency;

wherein the packetized message is transmitted on a third frequency which differs from the first frequency and the second frequency;

wherein the second upstream signaling information is transmitted on a fourth frequency which differs from the first frequency, the second frequency and the third frequency;

wherein the third downstream signaling information is received on a fifth frequency which differs from the first frequency, the second frequency, the third frequency; and the fourth frequency; and

26

wherein the third upstream signaling information is transmitted on a sixth frequency which differs from the first frequency, the second frequency, the third frequency, the fourth frequency and the fifth frequency.

**55.** The first node of claim **46**,

wherein the packetized message comprises data packets; wherein the data packets may include information related to a sequence number; and

wherein a final data packet from the packetized message may further comprise information related to terminal indication information indicating that the final data packet is a last data packet.

**56.** The first node of claim **46**, wherein the first node further comprises a touch sensitive display input device.

**57.** The first node of claim **46**, wherein the availability of said first slot allocated to the first node recurs until use of the first slot by the first node is disabled.

**58.** A first node comprising:

at least one processor;

a memory; and

at least one interface configured to:

transmit first upstream signaling information from the first node, said first upstream signaling information comprising a reserve request which is transmitted within a first slot allocated to the first node;

receive first downstream signaling information, said first downstream signaling information being received subsequent to transmission of the reserve request, said first downstream signaling information comprising an allocation of resources to the first node for transmitting a packetized message;

transmit the packetized message subsequent to receiving the first downstream signaling information;

receive second downstream signaling information comprising information describing a new cell;

transmit second upstream signaling information, said second upstream signaling information comprising a random access request in a second slot;

receive third downstream signaling information, said third downstream signaling information being received subsequent to transmission of the second upstream signaling information, said third downstream signaling information acknowledging receipt of said second upstream signaling information, said third downstream signaling information comprising information referencing a second slot number wherein the first node transmitted said random access request in order for the first node to identify that the first node is an intended recipient of the third downstream signaling information;

transmit third upstream signaling information from the first node, said third upstream signaling information being transmitted subsequent to receiving said third downstream signaling information,

said third upstream signaling information from the first node comprising identifier information for the first node;

receive fourth downstream signaling information and determining that the first node must perform a handoff procedure; and

receive fifth downstream signaling information, said fifth downstream signaling information being received subsequent to transmission of the third upstream signaling information, said fifth downstream signaling information comprising an allocation of a third slot to the first node for transmitting a subsequent reserve request;



27

wherein the availability of said third slot allocated to the first node recurs until use of the third slot by the first node is disabled, and  
 wherein an additional reserve request transmitted by a second node into a fourth slot allocated to the second node can be transmitted during transmission of the packetized message by the first node.

59. The first node of claim 58,  
 wherein said additional reserve request transmitted by the second node is transmitted on a differing frequency than said packetized message transmitted by the first node.

60. The first node of claim 58,  
 wherein the first upstream signaling information is transmitted on a first frequency;  
 wherein the third downstream signaling information is received on a second frequency which differs from the first frequency; and  
 wherein the second upstream signaling information is transmitted on a third frequency which differs from the first frequency and the second frequency.

61. The first node of claim 58,  
 wherein the first upstream signaling information is transmitted on a first frequency;  
 wherein the first downstream signaling information is received on a second frequency which differs from the first frequency; and  
 wherein the third downstream signaling information is received on a third frequency which differs from the first frequency and the second frequency.

62. The first node of claim 58,  
 wherein the first upstream signaling information is transmitted on a first frequency;  
 wherein the first downstream signaling information is received on a second frequency which differs from the first frequency; and  
 wherein the packetized message is transmitted on a third frequency which differs from the first frequency and the second frequency.

63. The first node of claim 62, wherein the first node receives aligning signaling information on a fourth frequency which differs from the first frequency, the second frequency and the third frequency.

64. The first node of claim 58,  
 wherein the first upstream signaling information is transmitted on a first frequency;  
 wherein the first downstream signaling information is received on a second frequency which differs from the first frequency;  
 wherein the second upstream signaling information is transmitted on a third frequency which differs from the first frequency and the second frequency; and  
 wherein the third downstream signaling information is received on a fourth frequency which differs from the first frequency, the second frequency and the third frequency.

65. The first node of claim 58,  
 wherein the first upstream signaling information is transmitted on a first frequency;  
 wherein the first downstream signaling information is received on a second frequency which differs from the first frequency;  
 wherein the packetized message is transmitted on a third frequency which differs from the first frequency and the second frequency;

28

wherein the second upstream signaling information is transmitted on a fourth frequency which differs from the first frequency, the second frequency and the third frequency; and  
 wherein the third downstream signaling information is received on a fifth frequency which differs from the first frequency, the second frequency, the third frequency; and the fourth frequency.

66. The first node of claim 58,  
 wherein the first upstream signaling information is transmitted on a first frequency;  
 wherein the first downstream signaling information is received on a second frequency which differs from the first frequency;  
 wherein the packetized message is transmitted on a third frequency which differs from the first frequency and the second frequency;  
 wherein the second upstream signaling information is transmitted on a fourth frequency which differs from the first frequency, the second frequency and the third frequency;  
 wherein the third downstream signaling information is received on a fifth frequency which differs from the first frequency, the second frequency, the third frequency; and the fourth frequency; and  
 wherein the third upstream signaling information is transmitted on a sixth frequency which differs from the first frequency, the second frequency, the third frequency, the fourth frequency and the fifth frequency.

67. The first node of claim 58,  
 wherein the packetized message comprises data packets; wherein the data packets may include information related to a sequence number, and  
 wherein a final data packet from the packetized message may further comprise information related to terminal indication information indicating that the final data packet is a last data packet.

68. The first node of claim 58, wherein the first node further comprises a touch sensitive display input device.

69. The first node of claim 58, wherein the availability of said first slot allocated to the first node recurs until use of the first slot by the first node is disabled.

70. A first node comprising:  
 at least one processor;  
 a memory; and  
 at least one interface configured to:  
 receive first downstream signaling information, said first downstream signaling information authorizing communication from the first node;  
 transmit first upstream signaling information from the first node, said first upstream signaling information being transmitted subsequent to receiving said first downstream signaling information, said first upstream signaling information being transmitted to acknowledge receipt of said authorization for communication;  
 receive second downstream signaling information, said second downstream signaling information being received subsequent to transmission of the first upstream signaling information, said second downstream signaling information comprising an allocation of a slot to the first node for transmitting a reserve request;  
 transmit second upstream signaling information from the first node, said second upstream signaling information being transmitted subsequent to receiving the second downstream signaling information, said sec-

29

ond upstream signaling information comprising the reserve request which is transmitted within the slot allocated to the first node;

receive third downstream signaling information, said third downstream signaling information received subsequent to transmission of the reserve request, said third downstream signaling information comprising an allocation of resources for transmitting a packetized message; and

transmit the packetized message subsequent to receiving said third downstream signaling information; wherein the packetized message comprises data packets; and

wherein the availability of the slot allocated to the first node recurs until use of the slot by the first node is disabled.

**71.** The first node of claim **70**, wherein a additional reserve request transmitted by a second node into a additional slot allocated to the second node that can be transmitted during transmission of the packetized message by the first node, wherein said additional reserve request transmitted by the second node is transmitted on a differing frequency than said packetized message transmitted by the first node.

**72.** The first node of claim **70**, wherein a additional reserve request transmitted by a second node into a additional slot allocated to the second node can be transmitted during transmission of the packetized message by the first node.

**73.** The first node of claim **70**, wherein the first upstream signaling information is transmitted on a first frequency;

wherein the first downstream signaling information is received on a second frequency which differs from the first frequency; and

wherein the second upstream signaling information is transmitted on a third frequency which differs from the first frequency and the second frequency.

**74.** The first node of claim **70**,

wherein the first upstream signaling information is transmitted on a first frequency;

wherein the first downstream signaling information is received on a second frequency which differs from the first frequency; and

wherein the third downstream signaling information is received on a third frequency which differs from the first frequency and the second frequency.

**75.** The first node of claim **70**,

wherein the second upstream signaling information is transmitted on a first frequency;

wherein the third downstream signaling information is received on a second frequency which differs from the first frequency; and

wherein the packetized message is transmitted on a third frequency which differs from the first frequency and the second frequency.

**76.** The first node of claim **75**, wherein the first node receives aligning signaling information on a fourth frequency which differs from the first frequency, the second frequency and the third frequency.

**77.** The first node of claim **70**,

wherein the first downstream signaling information is received on a first frequency;

wherein the first upstream signaling information is transmitted on a second frequency which differs from the first frequency;

30

wherein the second upstream signaling information is transmitted on a third frequency which differs from the first frequency and the second frequency; and

wherein the third downstream signaling information is received on a fourth frequency which differs from the first frequency, the second frequency, and the third frequency.

**78.** The first node of claim **70**,

wherein the first downstream signaling information is received on a first frequency;

wherein the first upstream signaling information is transmitted on a second frequency which differs from the first frequency;

wherein the second upstream signaling information is transmitted on a third frequency which differs from the first frequency and the second frequency;

wherein the third downstream signaling information is received on a fourth frequency which differs from the first frequency, the second frequency and the third frequency; and

wherein the packetized message is transmitted on a fifth frequency which differs from the first frequency, the second frequency, the third frequency and the fourth frequency.

**79.** The first node of claim **70**,

wherein the data packets may include information related to a sequence number, and

wherein a final data packet from the packetized message may further comprise information related to terminal indication information indicating that the final data packet is a last data packet.

**80.** The first node of claim **70**, wherein the first node further comprises a touch sensitive display input device.

**81.** The first node of claim **70**, wherein said third downstream signaling information is provided to the first node in recurring subsequent downstream transmissions.

**82.** A first node comprising:

at least one processor;

a memory; and

at least one interface configured to:

receive first downstream signaling information, said first downstream signaling information comprising information referencing a first slot number wherein the first node transmitted a request in order for the first node to identify that the first node is an intended recipient of the first downstream signaling information;

transmit first upstream signaling information from the first node, said first upstream signaling information being transmitted subsequent to receiving said first downstream signaling information, said first upstream signaling information from the first node comprising identifier information for the first node;

receive second downstream signaling information, said second downstream signaling information being received subsequent to transmission of the first upstream signaling information, said second downstream signaling information comprising an allocation of a second slot to the first node for transmitting a reserve request;

transmit second upstream signaling information from the first node, said second upstream signaling information being transmitted subsequent to receiving the second downstream signaling information, said second upstream signaling information comprising the reserve request which is transmitted within the second slot allocated to the first node;

31

receive third downstream signaling information, said third downstream signaling information received subsequent to transmission of the reserve request, said third downstream signaling information comprising an allocation of resources for transmitting a packetized message; and

transmit the packetized message subsequent to receiving the third downstream signaling information, wherein the availability of said second slot allocated to the first node recurs until use of the second slot by the first node is disabled.

**83.** The first node of claim **82**,

wherein an additional reserve request transmitted by a second node into a third slot allocated to the second node can be transmitted during transmission of the packetized message by the first node, and

wherein said additional reserve request transmitted by the second node is transmitted on a differing frequency than said packetized message transmitted by the first node.

**84.** The first node of claim **82**,

wherein the first upstream signaling information is transmitted on a first frequency;

wherein the first downstream signaling information is received on a second frequency which differs from the first frequency; and

wherein the second upstream signaling information is transmitted on a third frequency which differs from the first frequency and the second frequency.

**85.** The first node of claim **82**,

wherein the first upstream signaling information is transmitted on a first frequency;

wherein the first downstream signaling information is received on a second frequency which differs from the first frequency; and

wherein the third downstream signaling information is received on a third frequency which differs from the first frequency and the second frequency.

**86.** The first node of claim **82**,

wherein the second upstream signaling information is transmitted on a first frequency;

wherein the third downstream signaling information is received on a second frequency which differs from the first frequency; and

wherein the packetized message is transmitted on a third frequency which differs from the first frequency and the second frequency.

**87.** The first node of claim **86**, wherein the first node receives aligning signaling information on a fourth frequency which differs from the first frequency, the second frequency and the third frequency.

**88.** The first node of claim **82**,

wherein the first downstream signaling information is received on a first frequency;

wherein the first upstream signaling information is transmitted on a second frequency which differs from the first frequency;

wherein the second upstream signaling information is transmitted on a third frequency which differs from the first frequency and the second frequency; and

wherein the third downstream signaling information is received on a fourth frequency which differs from the first frequency, the second frequency and the third frequency.

**89.** The first node of claim **82**,

wherein the first downstream signaling information is received on a first frequency;

32

wherein the first upstream signaling information is transmitted on a second frequency which differs from the first frequency;

wherein the second upstream signaling information is transmitted on a third frequency which differs from the first frequency and the second frequency;

wherein the third downstream signaling information is received on a fourth frequency which differs from the first frequency, the second frequency and the third frequency; and

wherein the packetized message is transmitted on a fifth frequency which differs from the first frequency, the second frequency, the third frequency and the fourth frequency.

**90.** The first node of claim **82**,

wherein the packetized message comprises data packets; wherein the data packets may include information related to a sequence number, and

wherein a final data packet from the packetized message may further comprise information related to terminal indication information indicating that the final data packet is a last data packet.

**91.** The first node of claim **82**, wherein the first node further comprises a touch sensitive display input device.

**92.** The first node of claim **82**, wherein said third downstream signaling information is provided to the first node in recurring subsequent downstream transmissions.

**93.** A first node comprising:

at least one processor;

a memory; and

at least one interface configured to:

transmit first upstream signaling information from the first node, said first upstream signaling information comprising a reserve request which is transmitted within a first slot allocated to the first node;

receive first downstream signaling information, said first downstream signaling information being received subsequent to transmission of the reserve request, said first downstream signaling information comprising an allocation of resources to the first node for transmitting a packetized message;

transmit the packetized message subsequent to receiving the first downstream signaling information;

receive second downstream signaling information comprising information describing a new cell and determining that the first node must perform a handoff procedure, said handoff procedure comprising the following steps:

transmit second upstream signaling information, said second upstream signaling information comprising a random access request in a second slot;

receive third downstream signaling information, said third downstream signaling information being received subsequent to transmission of the second upstream signaling information, said third downstream signaling information acknowledging receipt of said second upstream signaling information, said third downstream signaling information comprising information referencing a second slot number wherein the first node transmitted said random access request in order for the first node to identify that the first node is an intended recipient of the third downstream signaling information;

transmit third upstream signaling information from the first node, said third upstream signaling information being transmitted subsequent to receiving said third downstream signaling information, said

33

third upstream signaling information from the first node comprising identifier information for the first node; and

receive fourth downstream signaling information, said fourth downstream signaling information being received subsequent to transmission of the third upstream signaling information, said fourth downstream signaling information comprising an allocation of a third slot to the first node for transmitting a subsequent reserve request; wherein the availability of the third slot by the first node recurs in repeated transmissions until use of the third slot by the first node is disabled.

**94.** The first node of claim **93**,

wherein a additional reserve request transmitted by a second node into a fourth slot allocated to the second node that can be transmitted during transmission of the packetized message by the first node; and

wherein said additional reserve request transmitted by the second node is transmitted on a differing frequency than said packetized message transmitted by the first node.

**95.** The first node of claim **93**, wherein a additional reserve request transmitted by a second node into a fourth slot allocated to the second node can be transmitted during transmission of the packetized message by the first node.

**96.** The first node of claim **93**,

wherein the first upstream signaling information is transmitted on a first frequency;

wherein the third downstream signaling information is received on a second frequency which differs from the first frequency; and

wherein the second upstream signaling information is transmitted on a third frequency which differs from the first frequency and the second frequency.

**97.** The first node of claim **93**,

wherein the first upstream signaling information is transmitted on a first frequency;

wherein the first downstream signaling information is received on a second frequency which differs from the first frequency; and

wherein the third downstream signaling information is received on a third frequency which differs from the first frequency and the second frequency.

**98.** The first node of claim **93**,

wherein the first upstream signaling information is transmitted on a first frequency;

wherein the first downstream signaling information is received on a second frequency which differs from the first frequency; and

wherein the packetized message is transmitted on a third frequency which differs from the first frequency and the second frequency.

**99.** The first node of claim **93**,

wherein the first upstream signaling information is transmitted on a first frequency;

wherein the first downstream signaling information is received on a second frequency which differs from the first frequency;

wherein the second upstream signaling information is transmitted on a third frequency which differs from the first frequency and the second frequency; and

wherein the third downstream signaling information is received on a fourth frequency which differs from the first frequency, the second frequency and the third frequency.

34

**100.** The first node of claim **93**,

wherein the first upstream signaling information is transmitted on a first frequency;

wherein the first downstream signaling information is received on a second frequency which differs from the first frequency;

wherein the packetized message is transmitted on a third frequency which differs from the first frequency and the second frequency;

wherein the second upstream signaling information is transmitted on a fourth frequency which differs from the first frequency, the second frequency and the third frequency; and

wherein the third downstream signaling information is received on a fifth frequency which differs from the first frequency, the second frequency, the third frequency; and the fourth frequency.

**101.** The first node of claim **93**,

wherein the first upstream signaling information is transmitted on a first frequency;

wherein the first downstream signaling information is received on a second frequency which differs from the first frequency;

wherein the packetized message is transmitted on a third frequency which differs from the first frequency and the second frequency;

wherein the second upstream signaling information is transmitted on a fourth frequency which differs from the first frequency, the second frequency and the third frequency;

wherein the third downstream signaling information is received on a fifth frequency which differs from the first frequency, the second frequency, the third frequency and the fourth frequency; and

wherein the third upstream signaling information is transmitted on a sixth frequency which differs from the first frequency, the second frequency, the third frequency, the fourth frequency and the fifth frequency.

**102.** The first node of claim **93**,

wherein the packetized message comprises data packets; wherein the data packets may include information related to a sequence number, and

wherein a final data packet from the packetized message may further comprise information related to terminal indication information indicating that the final data packet is a last data packet.

**103.** The first node of claim **93**, wherein the first node further comprises a touch sensitive input device.

**104.** The first node of claim **93**, wherein the availability of said first slot allocated to the first node recurs in repeated transmissions until use of the first slot by the first node is disabled.

**105.** A node comprising:

at least one processor;

a memory; and

at least one interface configured to:

transmit random access request signaling information in a first slot, the random access request signaling information conveying information that allows determination that the node requires an allocation of resources to transmit reserve access request signaling information;

receive first grant signaling information subsequent to transmission of the random access request signaling information, said first grant signaling information including information relating to an allocation of a second slot to the node for transmitting the reserve

35

access request signaling information for subsequently transmitting data packets containing a message;  
 receive aligning signaling information which enables the node to transmit the reserve access request signaling information;  
 transmit the reserve access request signaling information in the second slot subsequent to receiving the first grant signaling information;  
 receive second grant signaling information subsequent to transmission of the reserve access request signaling information, said second grant signaling information allocating additional resources for transmitting the data packets;  
 transmit the data packets after receiving the second grant signaling information;  
 wherein randomly generated information generated by the node is returned to the node to enable identification of the node;  
 wherein the interface is further configured to transmit information relating to a count value;  
 wherein the interface is further configured to transmit terminal indication information indicating that a final data packet is a last data packet;  
 wherein the aligning signaling information is received on a first frequency, the reserve access request signaling information is transmitted on a second frequency, the second grant signaling information is received on a third frequency and the data packets are transmitted on a fourth frequency;  
 wherein the first frequency, the second frequency, the third frequency and the fourth frequency are differing frequencies; and  
 wherein the aligning signaling information is distinct from the first grant signaling information.

**106.** The node of claim **105**, wherein subscriber identification is transmitted from the node subsequent to the node receiving return of said randomly generated information.

**107.** The node of claim **105**, wherein the node further comprises a touch sensitive input device.

**108.** The node of claim **105**, wherein the interface is further configured to receive the aligning signaling information with which the node can synchronize signals.

**109.** The node of claim **108**, wherein the aligning signaling information with which the node can synchronize signals defines a frame boundary.

**110.** The node of claim **109**, wherein said aligning signaling information further defines timeslots with the frame boundary.

**111.** The node of claim **105**,  
 wherein subsequent to transmission of the data packets, the node receives a first acknowledgement on a downstream frequency, said first acknowledgement on the downstream frequency including information which informs the node that the data packets have been received; and  
 wherein subsequent to receiving the first acknowledgement on the downstream frequency, the node responds with a subsequent acknowledgement on a subsequent upstream frequency which acknowledges receipt of the first acknowledgement.

**112.** The node of claim **105**, wherein the third frequency may also carry downstream data packets to the node.

**113.** The node of claim **105**,  
 wherein a number of the differing frequencies comprises at least four frequency channels; and  
 wherein a number of transceivers of the node comprises less than the number of frequency channels but at least two transceivers.

36

**114.** The node of claim **105**, wherein the second grant signaling information is an op code which authorizes transmission of the data packets.

**115.** The node of claim **105**, wherein the random access request signaling information and the reserve access request signaling information contain digital information.

**116.** The node of claim **105**, wherein the randomly generated information is at least one of information that is randomly generated by the node and information related to a slot number.

**117.** The node of claim **105**, wherein said information that allows determination that the node requires an allocation of resources to transmit reserve access request signaling information comprises randomly generated information by the node.

**118.** The node of claim **117** wherein the random access request signaling information and the reserve access request signaling information contain digital information.

**119.** The node of claim **117**, wherein the randomly generated information is at least one of information that is randomly generated by the node and information related to a slot number.

**120.** The node of claim **117**, wherein the second grant signaling information is an op code which authorizes transmission of the data packets.

**121.** The node of claim **105**, wherein a number of the differing frequencies for reserved slot operations allocated at any particular point in time for utilization by the node is constant at four frequencies.

**122.** The node of claim **121**, wherein subscriber identification is transmitted from the node subsequent to the node receiving return of said randomly generated information.

**123.** The node of claim **121**, wherein the node further comprises a touch sensitive input device.

**124.** The node of claim **121**, wherein the interface is further configured to receive the aligning signaling information with which the node can synchronize signals.

**125.** The node of claim **124** wherein the aligning signaling information with which the node can synchronize signals defines a frame boundary.

**126.** The node of claim **125**, wherein said aligning signaling information further defines timeslots with the frame boundary.

**127.** The node of claim **121**,  
 wherein subsequent to transmission of the data packets, the node receives a first acknowledgement on a downstream frequency, said first acknowledgement on the downstream frequency including information which informs the node that the data packets have been received; and  
 wherein subsequent to receiving the first acknowledgement on the downstream frequency, the node responds with a subsequent acknowledgement on a subsequent upstream frequency which acknowledges receipt of the first acknowledgement.

**128.** The node of claim **121**, wherein the third frequency may also carry downstream data packets to the node.

**129.** The node of claim **121**,  
 wherein a number of the differing frequencies comprises at least four frequency channels; and  
 wherein a number of transceivers of the node comprises less than the number of frequency channels but at least two transceivers.

**130.** The node of claim **121**, wherein the second grant signaling information is an op code which authorizes transmission of the data packets.

37

131. The node of claim 121, wherein the random access request signaling information and the reserve access request signaling information contain digital information.

132. The node of claim 121, wherein the randomly generated information is at least one of information that is randomly generated by the node and information related to a slot number.

133. The node of claim 121, wherein said information that allows determination that the node requires an allocation of resources to transmit reserve access request signaling information comprises randomly generated information by the node.

38

134. The node of claim 133, wherein the second grant signaling information is an op code which authorizes transmission of the data packets.

135. The node of claim 133, wherein the random access request signaling information and the reserve access request signaling information contain digital information.

136. The node of claim 133, wherein the randomly generated information is at least one of information that is randomly generated by the node and information related to a slot number.

\* \* \* \* \*